

SIEMENS

7₇₈₅



Burner Controls

LOK16...

LGK16...

Burner controls

- For gas, oil or dual-fuel forced draft burners of medium to high capacity
- For multistage or modulating burners in continuous operation
- With air pressure supervision for checked air damper control.
- Flame supervision
 - LOK16: With silicon detector RAR
 - LGK16: With flame detector QRA53/QRA55/ionization probe
- Burner control for oil burners or gas burners in accordance with EN 298:2012
- Suitable for use with air heaters (WLE)
- With self-checking flame signal amplifier

The LOK16.../LGK16... and this Data Sheet are intended for use by OEMs which integrate the burner controls in their products.



Use

Burner controls type LOK16.../LGK16... feature a self-checking flame supervision circuit.

The flame supervision circuit initiates the safety actions in the case of... :

- ... premature or missing flame signal
- ... any kind of fault on the flame detector, the detector cables or the flame signal amplifier that could simulate a flame signal during burner operation

The burner controls are therefore suited for use in all types of oil- or gas-fired combustion plant where self-checking flame supervision systems are either mandatory or recommended.

For example:

- Burners that operate continuously
- Burners in intermittent operation that, in the case of great heat demand, may operate continuously for more than 14 hours, e.g. in plant using boiler sequencing
- Burners that need to comply with the German TRD 411 and TRD 412 regulations for steam boilers
- Burners in plant where, for specific safety requirements, supervision of the burner by a self-checking flame supervision system seems advisable
- The control sequence and connection circuitry of the LOK16.../LGK16... burner controls are identical to those of the LAL2... and LFL1... respectively (with the exception of the LFL1.148), so that existing combustion plant can also be equipped with self-checking burner controls,
 - provided very good flame detector current values are measured in the plant supervised so far by the LFL1..., and
 - provided the following types of flame detectors are either installed or can subsequently be fitted:

Flame supervision when using LOK16...

- Photocell detector RAR9

Flame supervision when using LGK16...

- Flame detector QRA53.../QRA55...
- Ionization probe
- Flame detector QRA53.../QRA55... together with ionization probe, e.g. in the case of burners using a pilot burner (also see Data Sheet N7712)

Warning notes



To avoid injury to persons, damage to property or the environment, the following warning notes must be observed!

Do not open, interfere with or modify the unit!

- All activities (mounting, installation and service work, etc.) must be performed by qualified staff
- Before making any wiring changes in the connection area, completely isolate the plant from mains supply (all-polar disconnection). Ensure that the plant cannot be inadvertently switched on again and that it is indeed dead. If not observed, there is a risk of electric shock hazard
- Ensure protection against electric shock hazard by providing adequate protection for the burner control's connection terminals
- Each time work has been carried out (mounting, installation, service work, etc.), check to ensure that wiring is in an orderly state and make the safety checks as described in *Commissioning notes*
- Press the lockout reset button only manually (applying a force of no more than 10 N) without using any tools or pointed objects
- **Do not press the lockout reset button on the unit or the remote reset button (input 21) for more than 10 seconds, since this would damage the lockout relay inside the unit**
- Fall or shock can adversely affect the safety functions. Such units must not be put into operation, even if they do not exhibit any damage
- In the case of flame supervision with flame detectors QRA53 / QRA55, it should be noted that sources of radiation such as halogen lamps, welding equipment, special lamps, ignition sparks, as well as X-rays and gamma radiation, can produce erroneous flame signals

Mounting notes

- Ensure that the relevant national safety regulations are complied with.
- Connect the earthing lug inside the terminal base to burner ground using a screw with a lockwasher
- **An ignited UV tube is a source of UV radiation!**
If the flame is monitored by several flame detectors, all detectors must be placed in a way that ensures there is **no direct visual contact** between them.
If this is not observed, there is a risk of loss of safety functions

Upgrading existing plant

When equipping existing plants with LOK16 or LGK16, the existing plug-in base for LAL or LFL burner controls must be replaced with the matching plug-in base AGM17 for LOK16 / LGK16.

Start repetition in the event of loss of flame

By removing link (B) on the underside of the unit, the LOK16... can be switched to start repetition in the event of loss of flame during operation.
In that case, the wire link must be cut off completely.
However, it must be checked whether this is in compliance with national standards and regulations.



Note!

In applications involving air heaters (WLE), or in the case of oil burners with a maximum throughput of > 30 kW/h, removing wire link **B** is not permitted.

Installation notes

- Always run the high-voltage ignition cables separately while observing the greatest possible distance to the unit and to other cables
- Neutral conductors must not be interchanged
- Install switches, fuses, earthing, etc., in compliance with local regulations
- Make certain that the maximum permissible current rating of the connection terminals will not be exceeded
- The insulation of internal wiring that is exposed to the mains voltage must withstand the electrical stress occurring during correct use

Application notes



Note!

For use in applications in dual-fuel burners or oil burners, the oil supply must be equipped with two shutoff valves connected in series.

Observe the following:

EN 298:2012, Section 7.101.3.3 *Prepurge time for oil burner control systems and the corresponding application standards.*

Electrical connection of flame detectors

It is important to achieve practically disturbance- and loss-free signal transmission:

- Never run the detector cable together with other cables
 - Line capacitance reduces the magnitude of the flame signal
 - Use a separate cable
- Observe the permissible detector cable lengths (see Technical data)
- It is not permitted to connect 2 flame detectors QRA53.../QRA55... in parallel
- When using the QRA53.../QRA55..., earthing of terminal 22 is mandatory
- The ionization probe is not protected against electric shock hazard
- Locate the ignition electrode and ionization probe such that the ignition spark cannot arc over to the ionization probe (risk of electrical overloads) and that it cannot adversely affect the supervision of ionization
- Supervision with ionization probe and QRA53/QRA55 flame detector is possible but, for safety reasons, both must not be active at the same time, with the exception of the second safety time (t9). At the end of the second safety time, one of the detected flames must extinguish, e.g. by shutting down the pilot gas valve connected to terminal 17

Commissioning notes

When commissioning the plant or when doing maintenance work, make the following safety checks:

	Safety check to be carried out	Anticipated response
a)	Burner startup with flame detector darkened	Lockout at the end of safety time
b)	Burner startup with simulated flame	Lockout after no more than 40 seconds
c)	Burner operation with simulated loss of flame; for that purpose, darken the flame detector in operation and leave it in that state	LOK16... with wire link cut: Start repetition followed by lockout at the end of safety time LGK16... and LOK16... with wire link closed: Immediate lockout
d)	Burner startup with response of air pressure switch	Prevention of startup/lockout during prepurge time
e)	Burner operation with simulated air pressure failure	Immediate lockout

Commissioning notes

For the connection of valves and other components, the diagram of by the burner manufacturer is provide.

Standards and certificates



Applied directives:

- Low-voltage directive 2014/35/EC
- Directive for pressure devices 2014/68/EC
- Electromagnetic compatibility EMC (immunity) *) 2014/30/EC
- Only LGK16: Directive for gas-fired appliances 2009/142/EC

*) The compliance with EMC emission requirements must be checked after the burner control is installed in equipment

Compliance with the regulations of the applied directives is verified by the adherence to the following standards / regulations:

- Automatic burner control systems for burners and DIN EN 298 appliances burning gaseous or liquid fuels
- Only LGK16 Safety and control devices for gas burners and gas burning appliances DIN EN 13611: 2007-A2:2011
- Automatic electrical controls for household and similar use Part 2-5: Particular requirements for automatic electrical burner control systems DIN EN 60730-2-5

The relevant valid edition of the standards can be found in the declaration of conformity!



Note on **DIN EN 60335-2-102**

Household and similar electrical appliances - Safety - Part 2-102:

Particular requirements for gas, oil and solid-fuel burning appliances having electrical connections.

The electrical connections of the LMV5 and the PLL5 comply with the requirements of EN 60335-2-102.



EAC Conformity mark (Eurasian Conformity mark)



ISO 9001:2015
ISO 14001:2015
OHSAS 18001:2007



China RoHS
Hazardous substances table:
<http://www.siemens.com/download?A6V10883536>

Certified with plug-in base and flame detector:

Type reference							
LOK16.140...	---	---	●	●	●	●	---
LOK16.250...	---	---	●	●	●	●	---
LOK16.650...	---	---	●	●	●	●	---
LGK16.122...	●	●	●	---	---	●	●
LGK16.133A17	---	●	---	---	---	●	●
LGK16.133A27	●	●	●	---	---	●	●
LGK16.322...	●	●	●	---	---	●	●
LGK16.333...	●	●	●	---	---	●	●
LGK16.335...	●	●	●	---	---	●	●
LGK16.622...	●	●	●	---	---	●	●
LGK16.635...	●	●	●	---	---	●	●

Service notes

The KF8832 flame detector current measuring device must not be used in continuous operation.

Life cycle

Burner controls has a designed lifetime* of 250,000 burner startup cycles which, under normal operating conditions in heating mode, correspond to approx. 10 years of usage (starting from the production date given on the type field).

This lifetime is based on the endurance tests specified in standard EN 298. A summary of the conditions has been published by the European Control Manufacturers Association (Afecon - www.afecor.org).

The designed lifetime is based on use of the burner controls according to the manufacturer's Data Sheet. After reaching the designed lifetime in terms of the number of burner startup cycles, or the respective time of usage, the burner control is to be replaced by authorized personnel.

* The designed lifetime is not the warranty time specified in the Terms of Delivery

Disposal notes

The unit contains electrical and electronic components and must not be disposed of together with household waste. Local and currently valid legislation must be observed.

Mechanical design

LGK16.../LOK16...

- Plug-in design
- Exchangeable unit fuse (including spare fuse)

Housing

- Made of impact-proof and heat-resistant black plastic
- Lockout reset button with viewing window; located behind it are:
 - The lockout warning lamp
 - The lockout indicator
 - coupled to the spindle of the sequence switch
 - visible in the transparent lockout reset button
 - uses easy-to-remember symbols to indicate the type of fault and the point in time lockout occurred

Type summary

The type references given below apply to the LOK16 without plug-in base and without flame detector. For ordering information for plug-in bases and other accessories, see *Accessories*.

Switching times are given in the order of the startup sequence, valid for 50 Hz mains frequency. At 60 Hz, the times are about approx. 17% shorter.

The type references apply to burner controls operating on AC 230 V, 50...60 Hz.

* For burner controls operating on AC 100...110 V, 50...60 Hz, the last 2 digits of the type reference read «17» in place of «27».

LOK16...

For flame supervision with a photocell detector RAR9... for oil burners

Type	Preferred use:			Legend of times
	Flash-steam generators	Universal application	Medium- or heavy-oil burners	
Type	LOK16.140A27*	LOK16.250A27*	LOK16.650A27	
Article no.	BPZ:LOK16.140A27	BPZ:LOK16.250A27	BPZ:LOK16.650A27	
t1	10 s	22 s	66 s	Prepurge time with air damper fully open
TSA	4 s	5 s	5 s	Safety time or first safety time
TSA´	---	---	---	Safety time with burners using a pilot burner
t3	2 s	2.5 s	2.5 s	Preignition time
t3´	From startup command (with air pressure supervision: from receipt of air pressure signal)			Long preignition time
t3n	10 s	15 s	15 s	Postignition time (ignition transformer connected to terminal 15)
t4	8 s	7.5 s	7.5 s	Interval between start of safety time and release of valve at terminal 19
t4´	---	---	---	Interval between start of safety time and release of valve at terminal 19
t5	4 s	7.5 s	7.5 s	Interval between end of interval (t4/t4´) and release of load controller or valve at terminal 20
t6	10 s	15 s	15 s	Postpurge time (identical to permissible afterburn time (t13))
t7	2 s	2.5 s	2.5 s	Switch-on delay of fan motor (M2)
t8	30 s	47 s	91 s	Duration of startup without «t11» and «t12»
t9	---	---	---	Second safety time with burners using a pilot burner
t10	6 s	10 s	10 s	Interval from startup to the beginning of the air pressure check
t11	Optional			Air damper running time to the fully open position
t12	Optional			Air damper running time to the low-fire position
t13	10 s	15 s	15 s	Permissible afterburn time
t16	4 s	5 s	5 s	Interval from startup to the open command for the air damper
t20	32 s	34.5 s	12.5 s	Interval to self-shutdown of the sequence switch

Type summary (cont'd)

The type references given below apply to the LGK16 without plug-in base and without flame detector. For ordering information for plug-in bases and other accessories, see *Accessories*.

LGK16...

For flame supervision with flame detector QRA53.../QRA55... or ionization probe

	Preferred use:						
	Flash-steam generators	Flash-steam generators	Also suited for direct-fired air heaters)				
Type	LGK16.122A27*	LGK16.133A27	LGK16.322A27*	LGK16.333A27*	LGK16.335A27*	LGK16.622A27*	LGK16.635A27*
Article no.	BPZ:LGK16.122A27	BPZ:LGK16.133A27	BPZ:LGK16.322A27	BPZ:LGK16.333A27	BPZ:LGK16.335A27	BPZ:LGK16.622A27	BPZ:LGK16.635A27
t1	10 s	9 s	35.5 s	31.5 s	37 s	65 s	66 s
TSA	2 s	3 s	2 s	3 s	2.5 s	2 s	2.5 s
TSA´	2 s	3 s	2 s	3 s	5 s	2 s	5 s
t3	4 s	3 s	4 s	6 s	5 s	4 s	5 s
t3´	4 s	---	4 s	6 s	2.5 s	4 s	2.5 s
t3n	---	---	---	---	---	---	---
t4	6 s	6 s	10 s	11.5 s	12.5 s	10 s	12.5 s
t4´	6 s	---	10 s	11.5 s	15 s	10 s	15 s
t5	4 s	3 s	10 s	11.5 s	12.5 s	10 s	12.5 s
t6	10 s	14.5 s	12 s	17 s	15 s	12 s	15 s
t7	2 s	3 s	2 s	3 s	2.5 s	2 s	2.5 s
t8	30 s	29 s	65 s	69 s	74 s	95 s	103 s
t9	2 s	3 s	2 s	3 s	5 s	2 s	5 s
t10	6 s	6 s	8 s	11.5 s	10 s	8 s	10 s
t11	Optional						
t12	Optional						
t13	10 s	14.5 s	12 s	17 s	15 s	12 s	15 s
t16	4 s	3 s	4 s	6 s	5 s	4 s	5 s
t20	32 s	60 s	---	26 s	22 s	---	---

Accessories (to be ordered separately)

Oil burner controls, without plug-in base

For AC 230 V*	Control sequence and connection diagram like	Preferred use
LOK16.140A27*	LAL2.14	Flash-steam generators
LOK16.250A27*	LAL2.25	Universal application
LOK16.650A27	LAL2.65	Heavy-oil burners

* For burner controls operating on AC 100...110 V, 50...60 Hz, the last 2 digits of the type reference read «17» in place of «27»

Connection accessories for medium-capacity burner controls

Plug-in base **AGM16**
 Article no.: **BPZ:AGM16**
 - with Pg11 thread for cable entry glands



Plug-in base **AGM16.1**
 Article no.: **BPZ:AGM16.1**
 - with M16 thread for cable entry glands

see Data Sheet N7230

Flame detectors

Photocell detectors **RAR9...**
 see Data Sheet N7713



Accessories (to be ordered separately) (cont'd)

Gas burner controls, without plug-in base

For AC 230 V*	Control sequence and connection diagram like	Preferred use
LGK16.122A27*	LFL1.122	Flash-steam generators
LGK16.133A27	LFL1.133	Flash-steam generators
LGK16.322A27*	LFL1.322	Also suited for direct-fired air heaters
LGK16.333A27*	LFL1.333	
LGK16.335A27*	LFL1.335	
LGK16.622A27*	LFL1.622	
LGK16.635A27*	LFL1.635	

* For burner controls operating on AC 100...110 V, 50...60 Hz, the last 2 digits of the type reference read «17» in place of «27»

Connection accessories for medium-capacity burner controls

Plug-in base **AGM17**
 Article no.: **BPZ:AGM17**
 - with Pg11 thread for cable entry glands



Plug-in base **AGM17.1**
 Article no.: **BPZ:AGM17.1**
 - with M16 thread for cable entry glands

see Data Sheet N7230

Flame detectors

Flame detectors **QRA53.../QRA55...**
 see Data Sheet N7712



Ionization probe
 to be supplied by thirds



Accessories (to be ordered separately) (cont'd)

Actuators	Actuator SQN7 Refer to Data Sheet N7804	
	Actuator SQN3/SQN4 Refer to Data Sheet N7808	
	Actuator SQM40... / SQM41 Refer to Data Sheet N7817	
	Actuator SQM5... Refer to Data Sheet N7815	
Others	Flame detector current measuring device KF8832 Article no.: BPZ:KF8832 <ul style="list-style-type: none"> • For detector current measurements with QRA53..., QRA55... , recommended up to series C and E • Not suited for continuous operation • Only for measurements of short duration 	



Notice!
 The KF8832 negates the self-supervision function

Technical data

General unit data LOK16.../LGK16...	Mains voltage	AC 230 V -15% / +10% AC 100 V -15%...AC 110 V +10%	
	Mains frequency	50...60 Hz ±6%	
	Unit fuse, built-in	T6,3H250V to DIN EN 60 127	
	Primary fuse (external)	Max. 16 A (slow)	
	Weight	Approx. 1000 g	
	Power consumption	Approx. 3.5 VA	
	Perm. mounting position	Optional	
	Degree of protection	IP40, (to be ensured through mounting) with the exception of the connection area (terminal base)	
	Safety class	II	
	Perm. input current at terminal 1	Max. 5 A to VDE 0660 AC3	
	Perm. current load of control terminals	Max. 4 A to VDE 0660 AC3	
	Required switching capacity of switching devices		
	-Between terminals 4 and 5, 4 and 12	1A,AC250V	
	-Between terminals 4 and 14	depending on loading of terminals 15, 16, 18, 19 (LGK16...: 16...19), min. 1 A, AC 250 V	
	Permissible length of the standard detector cable (laid separately)	See <i>Technical data</i> , section <i>Flame supervision</i>	
	Capacity		
	-Output on startup (without fan)	Optional (with ignition < 120 kW)	
	-Nominal output	Optional	
	Environmental conditions	Storage	DIN EN 60721-3-1
		Climatic conditions	Class 1K3
Mechanical conditions		Class 1M2	
Temperature range		-20...+60 °C	
Humidity		<95% r.h.	
Transport		DIN EN 60721-3-2	
Climatic conditions		Class 2K3	
Mechanical conditions		Class 2M2	
Temperature range		-20...+60 °C	
Humidity		<95% r.h.	
Operation		DIN EN 60721-3-3	
Climatic conditions		Class 3K3	
Mechanical conditions		Class 3M3	
Temperature range		-20...+60 °C	
Humidity		<95% r.h.	
Installation altitude	Max. 2,000 m above sea level		

Caution!

Condensation, formation of ice and ingress of water are not permitted!
**If this is not observed, there is a risk of loss of safety functions and a risk
of electric shock**

Technical data (cont'd)

Flame supervision

	LOK16...	LGK16...		
	RAR9...	QRA5x.C... QRA5x.E...	QRA5x.D... QRA5x.G...	Ionization probe
Operating voltage (Terminal 23 or 24)	<DC1V ±10%	AC 280 V ¹⁾ ±10%	AC 280 V ¹⁾ ±10%	AC 245 V ¹⁾ ±10%
Minimum detector current required	DC6µA	DC 35 µA	DC 120 µA	DC 12 µA
Maximum possible detector current	DC 38 µA	DC 50 µA	DC 270 µA	DC 100 µA
Short-circuit current	---	---	---	Approx. AC 300 µA
Maximum length of detector cable (laid separately)	100 m	²⁾	²⁾	60 m ³⁾

- AC voltage, measured with no detector current at AC 230 V mains voltage. Internal resistance of measuring instrument 10 MΩ. The shutter of the flame detector QRA53.../QRA55... is powered by mains voltage **Max. 50 m**
- Detector cable laid in a minimum distance of 5 cm from other mains carrying cable: **Max. 70 m**
 - As a multiple cable - With 5 single wires **Max. 15 m**
 - With a shielded 3-core control cable to terminals 3, 4 and 5 of the flame detector QRA53.../QRA55... and standard mains cable to terminals 1 and 2 **Max. 60 m**
 - With 2 shielded single-core coaxial cables (≤45 pF/m, e.g. RG 62) to terminals 3 and 4 of the flame detector QRA53.../QRA55... and standard mains cable to terminals 1, 2 and 5
 - If possible, shielding should be earthed at both ends
- Longer cable distances are permitted when connecting low-capacitance detector cables to terminal 24 of the burner control (especially against earthed wires!)

Detector current measurement

Measuring circuit for detector current measurement

LOK16.../RAR9...

The measuring device must be connected between the detector and terminal 22 (+pole to terminal 22).

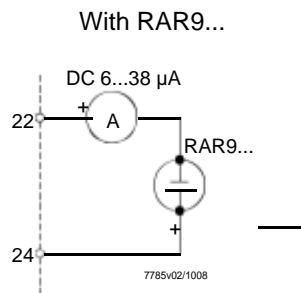

LGK16.../QRA53.../ QRA55...



Notice!
 Use the KF8832 measuring device (not suited for continuous operation).
 There is no self-checking while measurements are made.
 The KF8832 is not required when using the QRA5x.D.../QRA5x.G...

With QRA5x.C.../QRA5x.E...

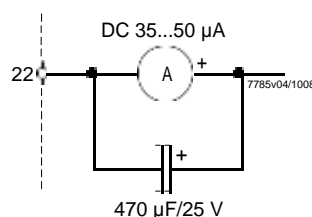

With QRA5x.D.../QRA5x.G...

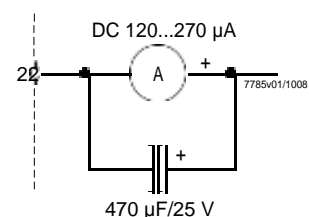

Detector current measurement (cont'd)

LGK16

The measuring device must be connected between terminal 24 and the detector electrode (+pole to terminal 24).

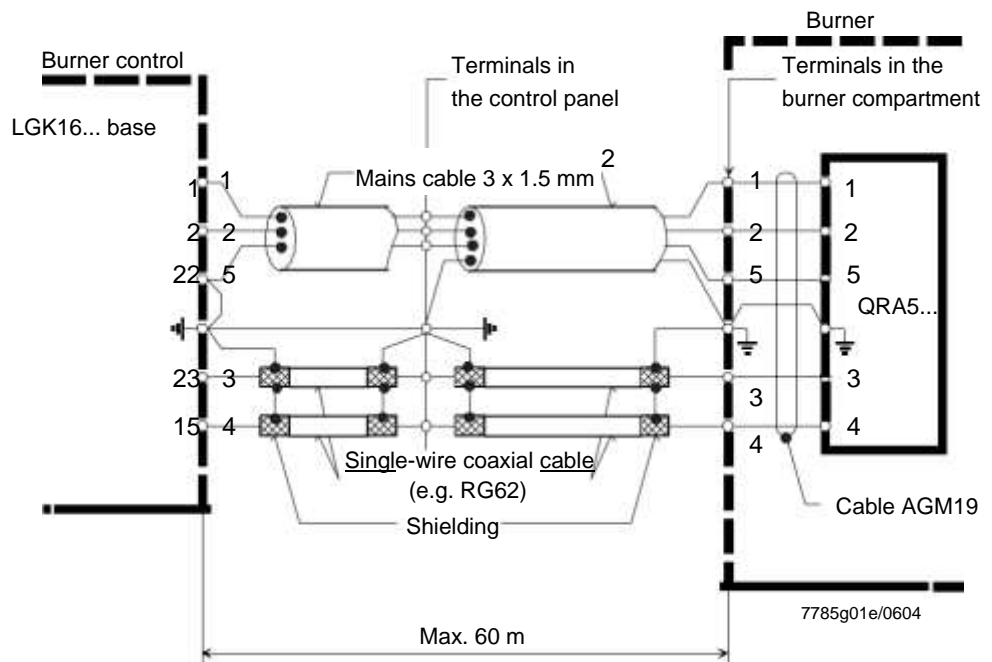
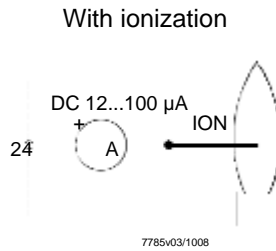

Legend

- A Ammeter
- RAR9... Silicon photocell detector
- ION Ionization probe

Function

Principle of self-supervision

In contrast to conventional amplifiers, the signal delivered by the flame detector is handled dynamically and not statically. The flame detector signal is converted to a sequence of control pulses and then fed to the flame relay circuit. The latter is designed such that the flame relay can only be energized by a flame signal of the described form. If the pulses change due to a faulty detector or faulty detector cables, the relay will be deenergized and the burner control triggers the required safety actions. In the case of UV supervision, it must also be ensured that self-ignition of the UV tube (e.g. due to aging) does not simulate a flame signal. For that reason, incident radiation at the UV cell is periodically interrupted by a shutter. In addition to the self-checking facility, the flame signal circuit is subjected to a functional test during the prepurge time. If it does not operate correctly, the startup sequence will be aborted or lockout initiated. Furthermore, if mains voltage drops to a level where safe operation of the burner control is no longer ensured, the burner will automatically shut down. When mains voltage returns to the normal level, the burner control repeats the startup sequence. If the detector signals are only slightly above the minimum levels, such mains voltage fluctuations can also give rise to burner lockout however.

Prerequisites for burner startup

- The burner control is reset and in the start position (terminals 11 and 12 must receive power)
- The air damper is closed. The end switch (z) for the CLOSED position must pass voltage from terminal 11 to terminal 8
- All control contacts between terminals 12 and 5 (limit thermostat, control thermostat, etc.) must be closed

Startup program

- A Start**
When control thermostat or pressurestat closes, the burner control's sequence switch starts running. At the same time, the fan motor connected to terminal 6 (only prepurging) receives power and, on completion of switch-on delay time, the fan motor or flue gas fan at terminal 7 (pre- and postpurging) also receives power. On completion of interval (t16), the control command to open the air damper is given via terminal 9. During the running time of the motor, the sequence switch does not operate, as terminal 8, via which the motor of the sequence switch first receives power, is not live during that period of time. The sequence switch starts again and begins the prepurge time (t1) only after the air damper is fully open and end switch «a» has changed over to feed power to terminal 8.
- t1 Prepurge time** with air damper fully open (nominal amount of combustion air)
Shortly after the start of the prepurge time, air pressure switch must change over, thus interrupting the current path between terminals 4 and 13. Otherwise, the burner control would go to lockout (start of air pressure check). At the same time, terminal 14 must be live since this current path is used to power the ignition transformer and the fuel valves.
- t3'** With the **LOK16...**, an ignition transformer connected to terminal 15 is therefore switched on at this point in time (long preignition). If there is no air pressure switch, the ignition transformer receives power already with the start command. On completion of the prepurge time, the burner control via terminal 10 drives the air damper into the low-fire position, which is determined by the changeover point of auxiliary switch (m). During the positioning time, the sequence switch stops again until terminal 8 receives power from «m».
- t5 Interval**
On completion of interval (t5), terminal 20 receives power. At the same time, control outputs 9 to 11 and input 8 are galvanically separated from the unit's control section, so that the latter is protected against reverse voltages from the load control circuit. The startup sequence of the burner control ends with the release of load controller at terminal 20. The sequence switch switches itself automatically off, depending on the time variant used, either immediately or after some so-called *idle steps*, that is, without changing the contact positions.

Expanding flame burners with LOK16... or LGK16...

- t3 Short preignition time**; followed by fuel release via terminal 18.
- TSA Safety time** (part load)
On completion of the safety time latest, a flame signal must be present at the input of the flame signal amplifier, or else the burner control will initiate lockout.

Only with LOK16...:
- t3n Postignition time** (provided the ignition transformer is connected to terminal 15).
- t4 Interval** until the fuel valve is released via terminal 19.

Startup program (cont'd)

Interrupted pilot burner with **LGK16** (burners using a pilot burner)

t3 **Short preignition time**; followed by release of fuel for the pilot burner via terminal 17.
t3'



Note! (Only for LGK)

For use in applications in dual-fuel burners or oil burners, the oil supply must be equipped with two shutoff valves connected in series.

Observe the following:

EN 298:2012, Section 7.101.3.3 *Prepurge time for oil burner control systems and the corresponding application standards.*

TSA **First safety time** (ignition load)

TSA' On completion of the safety time latest, a flame signal must be present at the input of the flame signal amplifier, or else the burner control will initiate lockout.

t4 **Interval** until the fuel valve at terminal 19 is released (start load of the main burner). Times safety
t4' time (TSA'), short preignition time (t3') and interval (t4') are only programmed by burner controls type **LGK16.335...** and **LGK16.635...**

t9 **Second safety time**

On completion of the safety time, the main burner must have been ignited by the pilot burner, since the pilot gas valve is closed on completion of second safety time (t9).

B **Operating position of the burner**

B - C **Burner operation** (generation of heat)

During burner operation, the load controller drives the air damper to the nominal load or low-fire position, depending on heat demand. Here, the nominal load is released by auxiliary switch (v) in the actuator.

C **Controlled shutdown by control thermostat or pressurestat**

In the case of controlled shutdown, the fuel valves are immediately closed and, at the same time, the sequence switch starts again to program the postpurge time (t6).

t6 **Postpurge time** (postpurging with fan (M2) connected to terminal 7).

Shortly after the start of the postpurge time, voltage at terminal 10 is reinstated, so that the air damper is driven into the MIN position. The full closing of the air damper starts only shortly before the completion of the postpurge time initiated by the control signal on terminal 11, which also remains live during the following burner off period.

t13 **Permissible afterburn time**

During permissible afterburn time (t13), the flame signal input may still receive a flame signal
→ No lockout

D - A **End of control sequence** (= start position)

When, on completion of postpurge time (t6), the sequence switch has reset the control contacts to their start positions, thereby switching itself off, the detector and flame simulation test is started again. However, during the burner off period, lockout can occur only if the faulty flame signal lasts a few seconds. Hence, short ignition pulses of the UV detector caused by cosmic radiation do not initiate lockout.

Control sequence in the event of fault and indication of lockout

In case of any disturbance, the supply of fuel will immediately be interrupted. At the same time, the sequence switch stops and thus the lockout indicator also.

The symbol appearing above the reading mark indicates the kind of fault:

- ◀ No start
 - One of the contacts is not closed (also see *Prerequisites for burner startup*)
 - Extraneous light
 Lockout during or after completion of the control sequence
 Example:
 - Flame not extinguished
 - Leaking fuel valves
 - Faulty flame supervision circuit

- = Abortion of startup sequence
 - No OPEN signal for end switch (a) at terminal 8
 - Terminals 6, 7 and 14 and, in case **LOK16...** is used, terminal 15, also remain live until the fault is corrected.

- P Lockout
 - The air pressure signal has not been received at the start of the air pressure check
 - Each air pressure failure after this time initiate also lockout.

- Lockout
 - Due to a fault in the flame supervision circuit.

- > Abortion of startup sequence,
 - Auxiliary switch (m) has not delivered the positioning signal for the low-fire position to terminal 8.
 - Terminals 6, 7 and 14 and, in case **LOK16...** is used, terminal 15, also remain live until the fault is corrected.

- 1 Lockout
 - No flame signal has been received on completion of the (first) safety time.

- 2 Lockout

Only with LGK16...:

 - No flame signal has been received on completion of the second safety time (flame signal of the main flame with interrupted pilot burners).

- I Lockout
 - The flame signal has been lost during burner operation
 - Air pressure failure

After the lockout reset, the burner control sequence switch first returns to the start position and then initiates a burner restart.

If lockout occurs any other moment in time between start and preignition not indicated by a symbol, the usual cause is a premature flame signal, that is, a faulty flame signal caused, for instance, by a self-igniting UV tube.

Only with LOK16...:

- If wire link (B) was cut off and the flame is lost during burner operation, the burner control programs a repetition of the startup sequence with the full program.

Control sequence in the event of fault and indication of lockout (cont'd)

Lockout indication

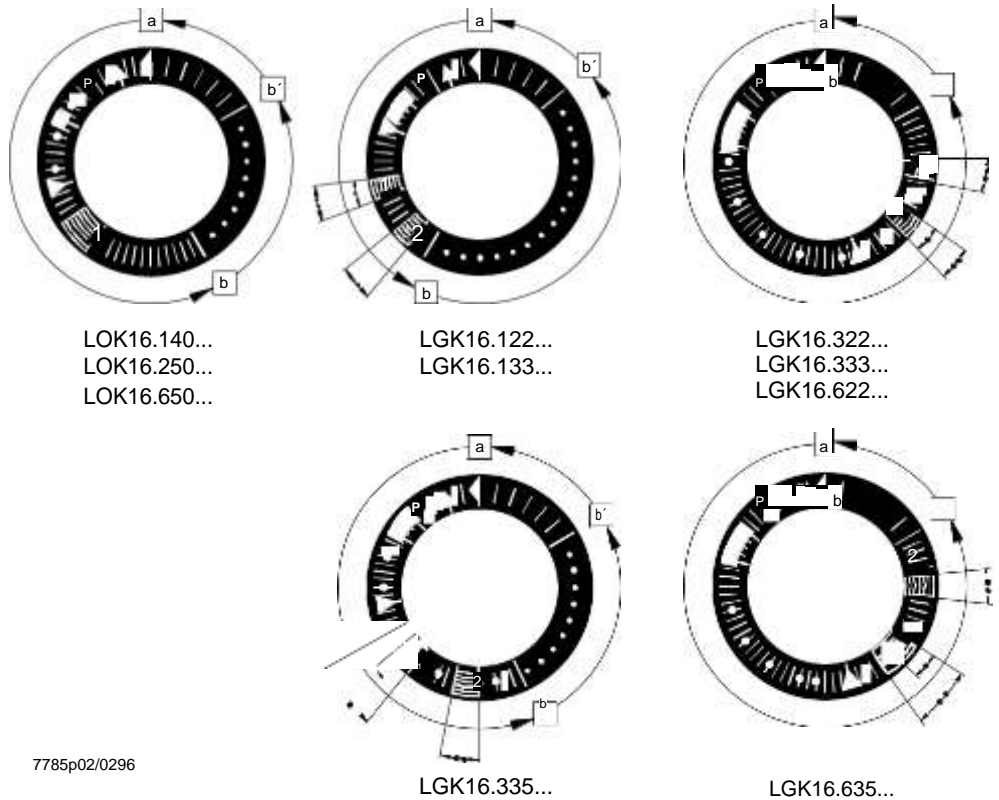

7785p02/0296

- a-b Startup sequence
- b-b' With certain time variants:
Idle steps of the sequence switch up to the self-shutdown after burner startup
 (b' = operating position of the sequence switch)
- b(b')-a Postpurge sequence after controlled shutdown.
 In start position (a), the sequence switch switches itself automatically off or immediately initiates another burner startup (e.g. after a fault has been corrected)
- Duration of safety time with expanding flame burners
- Duration of safety times with interrupted pilot burners

When lockout has occurred, the burner control can immediately be reset:
 → Do not press the lockout reset button for more than 10 seconds

The sequence switch always travels to the start position first
 → After resetting
 → After rectification of a fault that led to shutdown
 → After each power failure
 → During this period of time, power is only fed to terminals 7 and 9...11

After that, the burner control programmed the restarting of the burner



Note!
 Donot press the lockout reset button for more than 10 seconds.

Connection diagrams (for circuitry variants, see *Connection examples*)

LOK16...

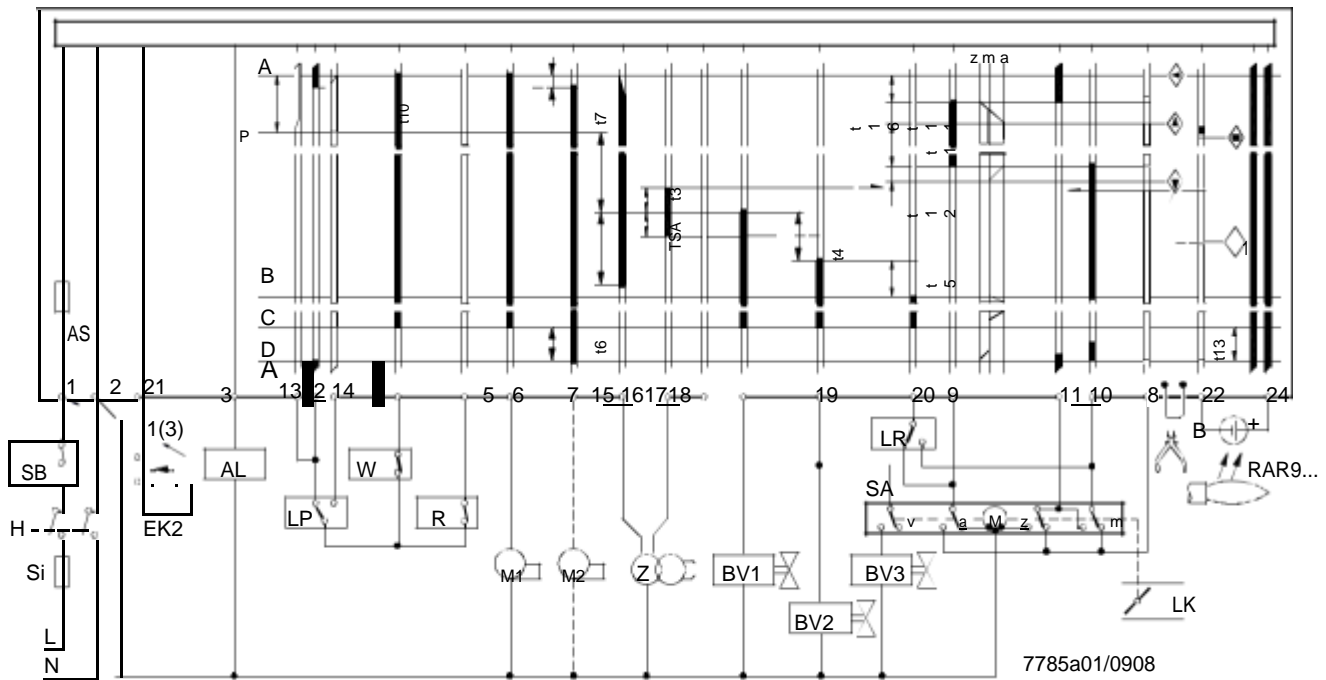

Note!

In applications involving air heaters (WLE), or in the case of oil burners with a maximum throughput of > 30 kW/h, removing wire link **B** is not permitted.



Caution!

Do not press lockout reset button (EK...) for more than 10 seconds!
 Connect the safety valve as specified in the diagram provided by the burner manufacturer.

Connection diagrams (for circuitry variants, see *Connection examples*) (cont'd)

LGK16...

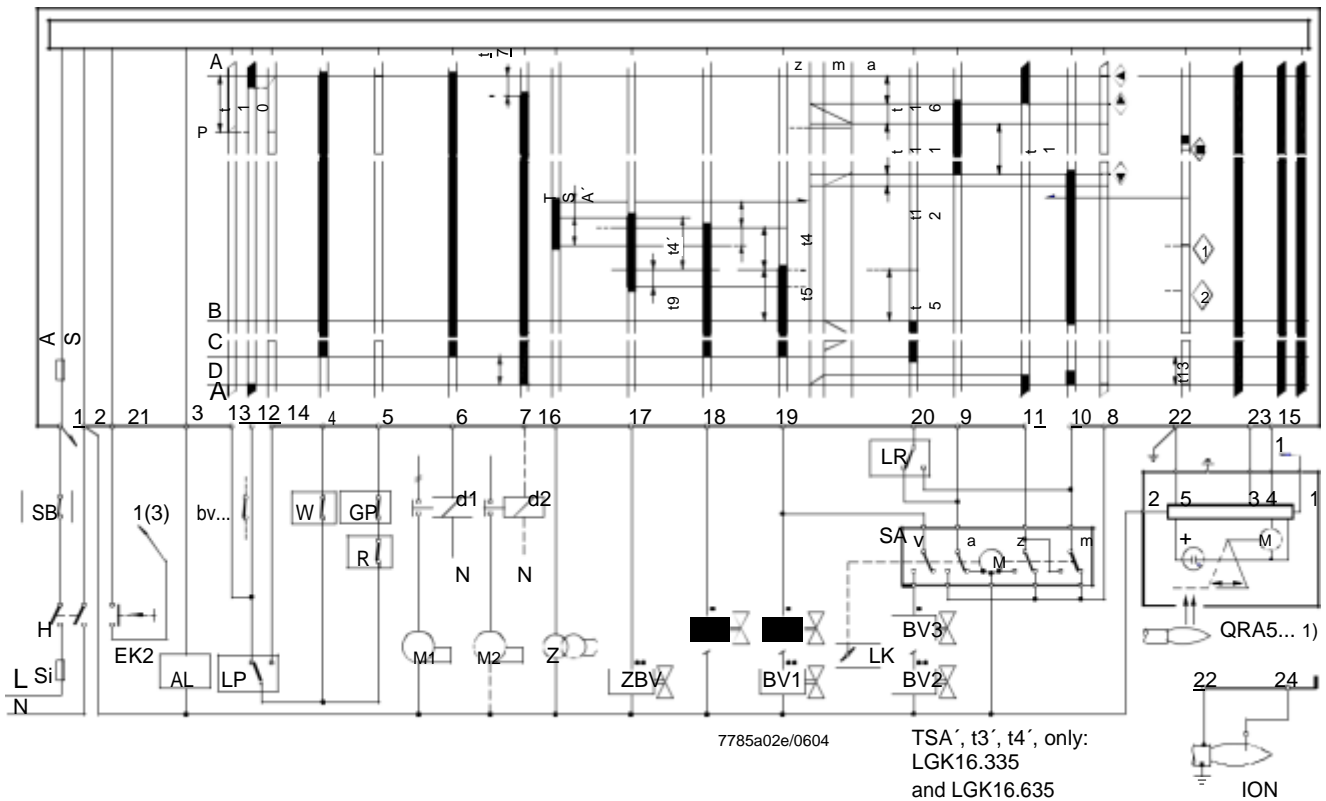

1) When used in connection with QRA53.../QRA55..., earthing of terminal 22 is mandatory!



Caution!
 Do not press lockout reset button (EK...) for more than 10 seconds!
 Connect the safety valve as specified in the diagram provided by the burner manufacturer.

Connection diagrams (for circuitry variants, see *Connection examples*)

LGK16...

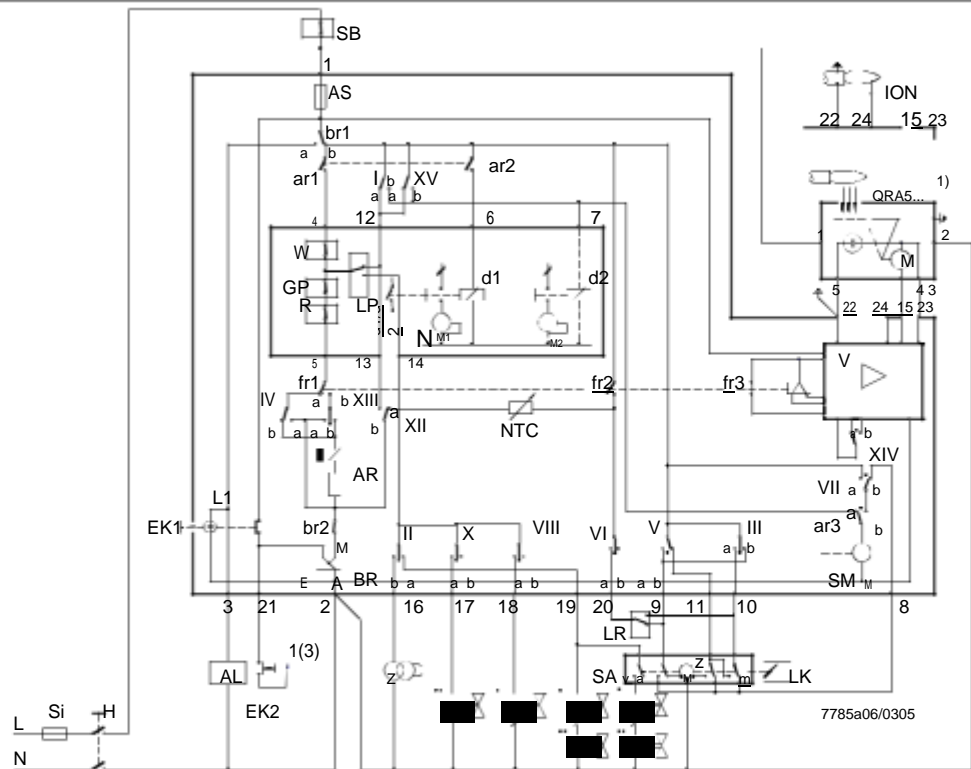

Caution!
 Do not press lockout reset button (EK...) for more than 10 seconds!

- 1) When used in connection with QRA53.../QRA55..., earthing of terminal 22 is mandatory!

LOK16...

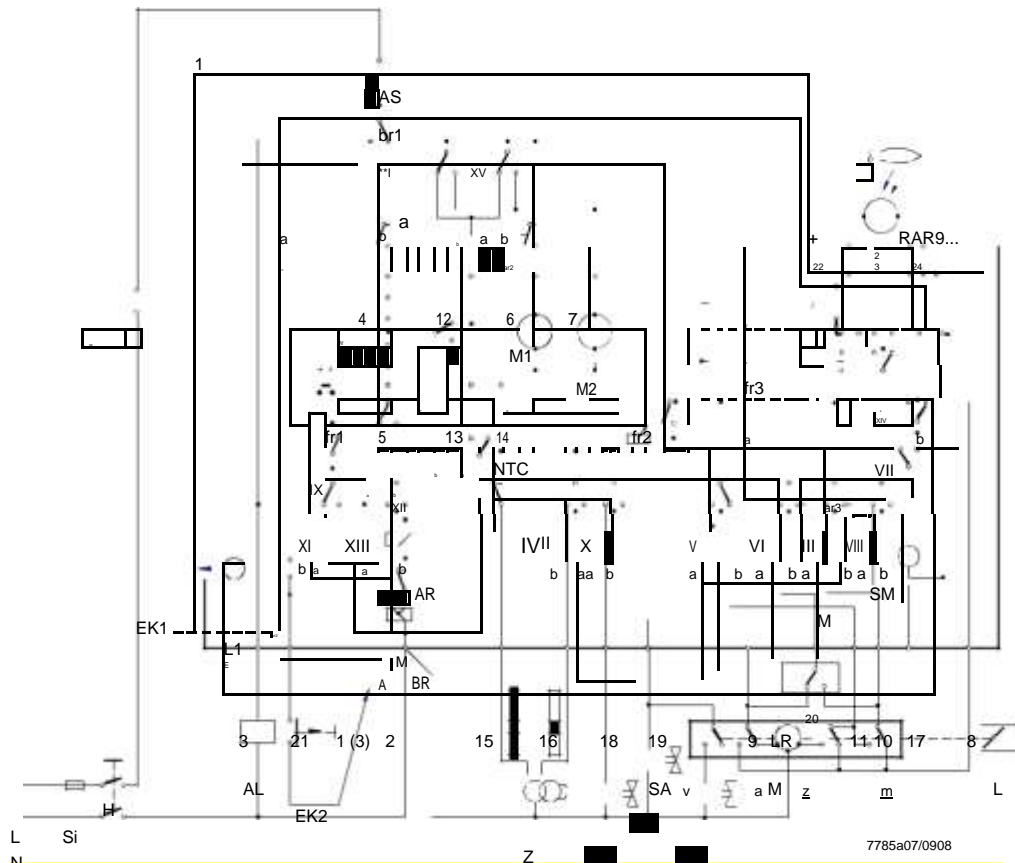

Caution!
 Do not press lockout reset button (EK...) for more than 10 seconds!

Program sequence

LGK16...

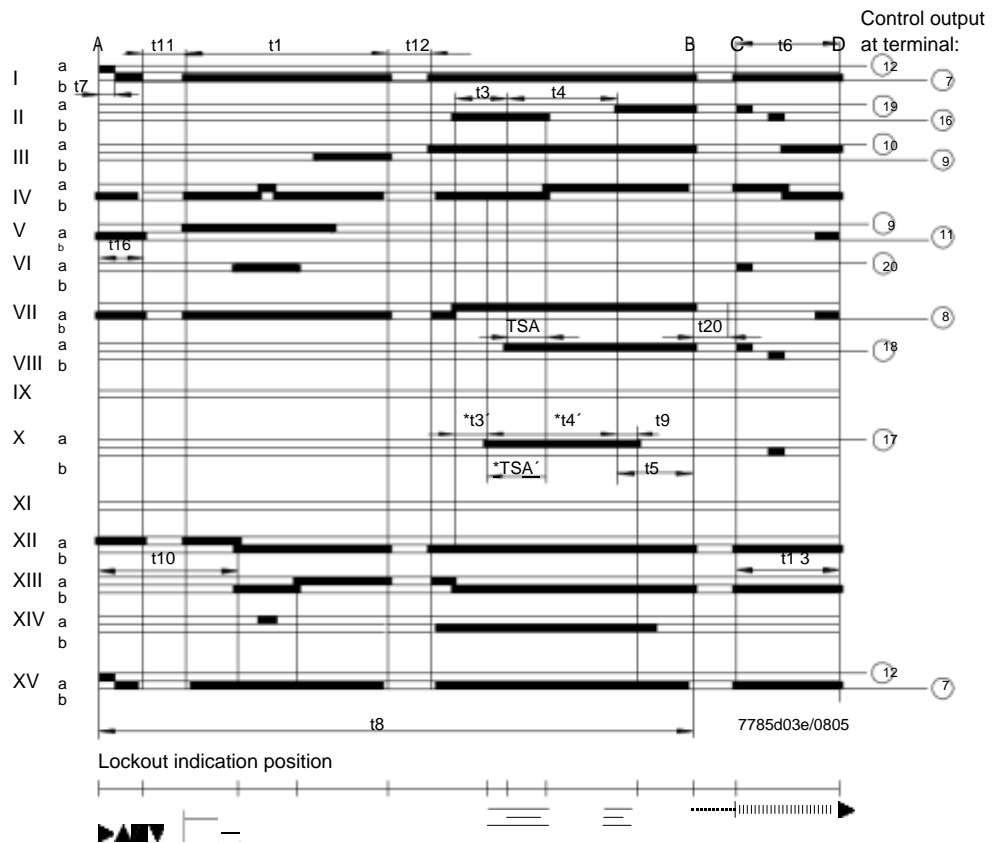

* Times safety time (TSA'), long preignition time (t3') and interval (t4') are only programmed by burner controls LGK16.335... and LGK16.635...

LOK16...

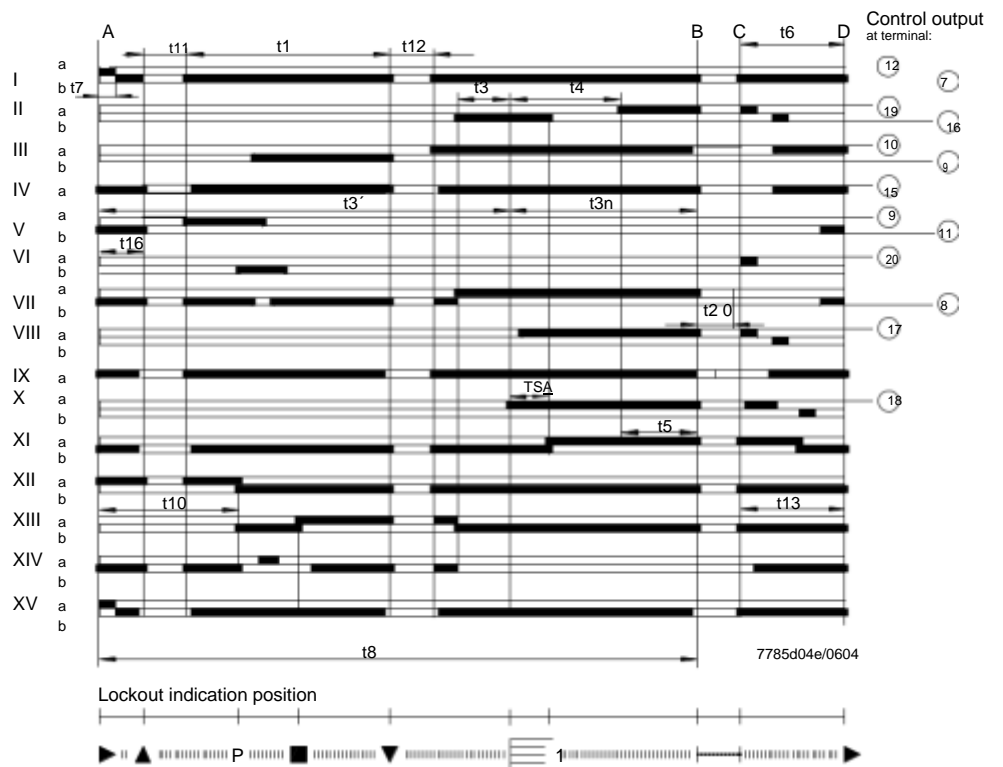

Program sequence (cont'd)

Expanding flame burners (burners without a pilot burner), controlled and supervised by **LOK16...** or **LGK16...**
 Air damper in low-fire position during burner off times (min.).

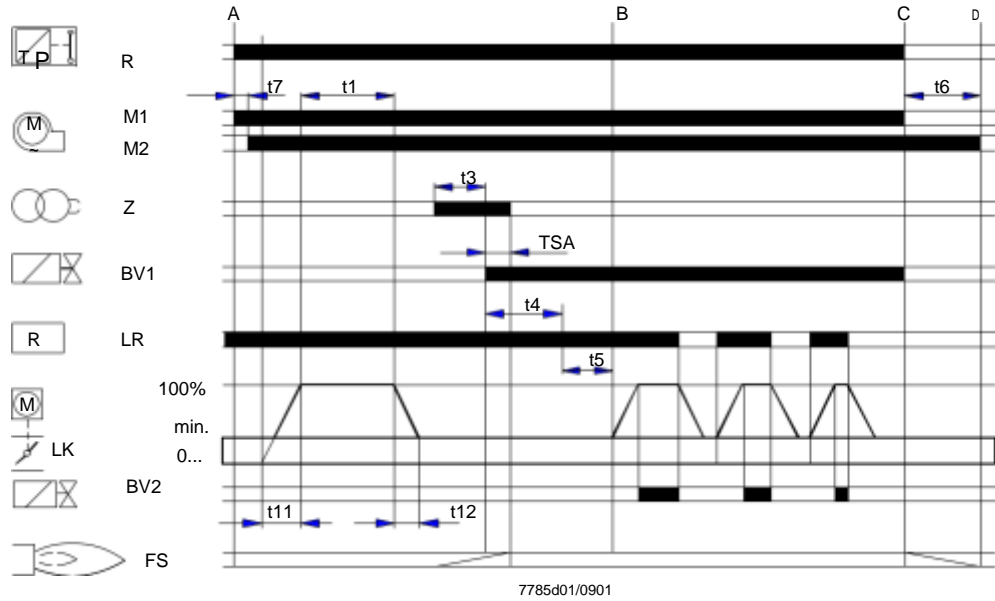

Interrupted pilot burners (burners with pilot burner), controlled and supervised by **LGK16.335** or **LGK16.635**, for example.
 The other types of burner controls of the LGK16... range program the times safety time (TSA), preignition time (t3), interval (t4) and second safety time (t9) for the pilot burner.

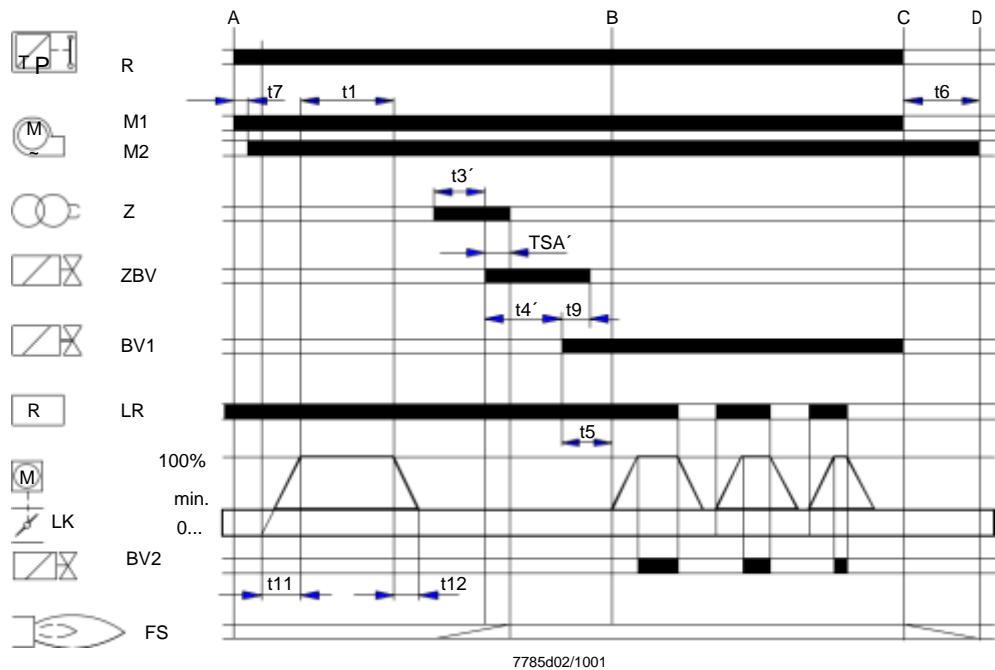

Connection examples

LGK16...

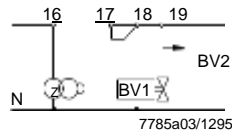

Doubling of safety time with expanding flame burners when using burner control **LGK16.335...** or **LGK16.635...**

By connecting terminals 17 and 18, the safety time is doubled and the preignition time reduced by 50%. Before using this circuit, it must be ensured that the longer safety time is in compliance with national standards and regulations etc. and with the construction of the burner plant!

LOK16...

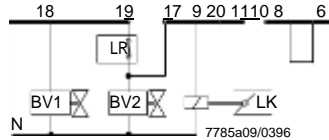

Control of the actuator during operation by feeding control signals to terminal 17

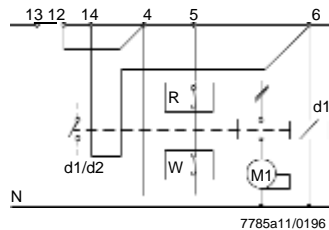

Wiring required for operation without air pressure supervision

If an auxiliary contact of the fan contactor is included in the circuit as shown in the diagram, ignition and fuel release are possible only when the contact is closed.

LOK16.../LGK16...

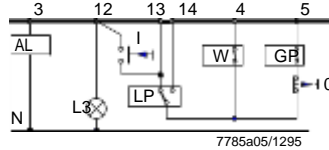

Semiautomatic startup

The burner is switched on manually by pressing button **I**. Then, the burner control programs the startup sequence and flame supervision.

The burner is switched off manually by pressing button **0**, or automatically by the limit thermostat or pressure switch (W), or by gas pressure switch (GP). Signal lamp (L3) indicates when the burner control is ready to be started; it extinguishes shortly after the burner is switched on.

For the other connections, see to the connection diagrams.

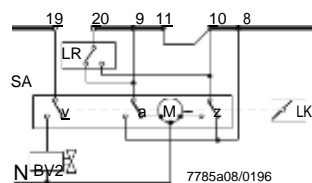

Connecting of actuators without end switch for the CLOSED position

Switch (Z) is set to low-fire

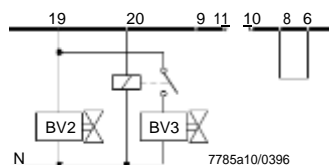

Control of a fuel valve by terminal 20 in the case of burners without air damper or with an air damper not controlled by the burner control.

The relay is not required if the valve connected to terminal 20 is hydraulically series-connected to a valve controlled by terminal 18 or 19. If no actuator is used, terminal 8 must be connected to terminal 6.

Legend

a	End switch for the OPEN position of the air damper
AL	Remote lockout warning device (alarm)
AR	Main relay (load relay) with «ar» contacts
AS	Unit fuse
B	Wire link (on the burner control's base)
	Note!
	In applications involving air heaters (WLE), or in the case of oil burners with a maximum throughput of > 30 kW/h, removing wire link B is not permitted.
BR	Lockout relay with «br» contacts
BV...	Fuel valve
bv...	Auxiliary contact in the valve actuator for the fully closed position check
d...	Contact or relay
EK...	Lockout reset button
ION	Ionization probe
FR	Flame relay with «fr» contacts
FS	Flame signal
GP	Gas pressure switch
H	Mains isolator
L...	Lockout warning lamp
LK	Air damper
LP	Air pressure switch
LR	Load controller
m	Auxiliary changeover switch for the air damper's MIN position
M...	Fan or burner motor
NTC	Resistor with negative temperature coefficient
QRA...	UV detector
R	Control thermostat or pressurestat
RAR9...	Silicon photocell detector
SA	Actuator of air damper
SB	Safety limit thermostat
Si	External fuse
SM	Synchronous motor of sequence switch
v	In the actuator: Auxiliary changeover switch for release of fuel as a function of the air damper position
V	Flame signal amplifier
W	Limit thermostat or pressure switch
z	In the actuator: End switch for the air damper's fully closed position
Z	Ignition transformer
ZBV	Pilot valve

- Valid for expanding flame burners
- Valid for interrupted pilot burners with a pilot burner which is shut down after the main burner has ignited

- A Startup
- B Operating position
- C Controlled shutdown
- D End of control sequence

 Control signals delivered by the burner control

 Permissible input signals

 Required input signals:

If these signals are not present at the points in time marked by symbols or during the shaded periods of time, the burner control will interrupt the startup sequence or initiate lockout

Legend (cont'd)

Lockout indication positions when there is no input signal (see *Control sequence in the event of faults*):

- ◀ No start
- ▲ Abortion of startup sequence
- ▼ Abortion of startup sequence
- Lockout (fault in the flame supervision circuit)
- 1 Lockout (no flame)
- 2 Lockout (no flame)
- P Lockout (no air)

pressure) Time table

- t1 Prepurge time with air damper fully open
 - TSA Safety time or first safety time with burners using a pilot burner
 - TSA' Safety time or first safety time with burners using a pilot burner
 - t3 Preignition time
 - t3' Preignition time
 - t3n Postignition time (ignition transformer connected to terminal 15)
 - t4 Interval between the start of safety time (TSA/TSA') to the valve connected to terminal 19
 - t4' Interval from the start of safety time (TSA/TSA') to the release of the valve connected to terminal 19
 - t5 Interval from the end of interval (t4/t4') to the release of the load controller or valve at terminal 20
 - t6 Postpurge time (identical with the permissible afterburn time (t13))
 - t7 Switch-on delay for fan motor M2
 - t8 Duration of startup sequence excluding running time (t11/t12)
 - t9 Second safety time with burners using a pilot burner
 - t10 Interval from the start to the beginning of the air pressure check
 - t11 Running time of air damper into the fully open position
 - t12 Running time of air damper into the low-fire position
 - t13 Permissible afterburn time
 - t16 Interval from the start to the OPEN command for the air damper
 - t20 Interval to the self-shutdown of the sequence switch
 - max. Safety time in the event of loss of flame during operation
- * Times safety time (TSA'), long preignition time (t3') and interval (t4') are only programmed by burner controls LGK16.335... and LGK16.635...

Dimensions

Dimensions in mm

LOK16.../LGK16...

 Plug-in base AGM17/AGM17.1

