

## Compact pressure switch for multiple actuators

**GW...A5**  
**GW...A5/1**

**DUNGS®**  
Combustion Controls



### Technical description

The GW...A5 pressure switch is a compact pressure switch as per EN 1854 for DUNGS multiple actuators.

The pressure switches are suitable **for switching a circuit on, off or over on changes in actual pressure relative to the set switching point (reference value).**

The switching point can be set easily and quickly using a setting wheel **provided with a scale without using a pressure gauge.**

### Application

Pressure switches for DUNGS multiple actuators GasMultiBloc and DMV **double solenoid valve which can be** either mounted directly on housing or by using an adapter.

Suitable for gases of families 1,2,3 and other neutral gaseous media.

### Approvals

- EC type testing certificate as per:**
- EC-Gas Appliances Regulation
  - **EC-Pressure Equipment Directive**

Pressure switch class "S" as per EN 1854.

**Approvals in other important gas-consuming countries.**

**Functional description**

**Single-acting pressure switch in over-pressure range.**  
 The pressure switches operate without any power supply.

**Switching response**

**GW...A5**

Short response time during pressure fluctuations.

**GW...A5/1**

Slow response time during short-term pressure fluctuations by additional damping nozzle.

**Pressure Switch**

The GW...A5 is a single-acting pressure switch acting in pressure range. The control unit responds to pressure.

**If the set reference value is exceeded or undershot, the circuit is switched on, off or over.**

**Switching function**

**As pressure rises:**

1 NC opens, 2 NO closes

**As pressure falls:**

1 NC closes, 2 NO opens

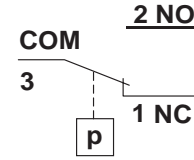

**Specifications**

<b>Max. operating pressure</b>	<b>GW 3 A5 - GW 150 A5</b> <b>GW 500 A5</b>	<b>500 mbar (50 kPa)</b> <b>600 mbar (60 kPa)</b>		
Pressure connection	<b>O ring flange connection on underside of pressure switch</b>			
Measuring connection	ø 9, length 10 mm, with screw plug			
Temperature range	Ambient temperature -15 °C to +70 °C Medium temperature -15 °C to +70 °C Storage temperature -30 °C to +80 °C			
Materials	<b>Housing:</b> <b>Switch:</b> <b>Diaphragms:</b> <b>Switching contact:</b>	<b>Aluminium die casting</b> <b>Polyamide</b> <b>NBR</b> <b>Ag</b>		
<b>Switching voltage</b>	<b>AC eff. min. 24 V</b> <b>DC min. 24 V</b>	<b>max. 250 V</b> <b>max. 48 V</b>		
Nominal current	<b>GW 10...500 A5</b> <b>AC eff. max. 10 A</b>	<b>GW 3 A5</b> <b>AC eff. max. 6 A</b>		
Switching current	<b>AC eff. max. 6 A</b> <b>AC eff. max. 3 A</b> <b>AC eff.</b> DC <b>DC</b>	<b>at cos φ 1</b> <b>at cos φ 0,6</b> <b>min. 20 mA</b> min. 20 mA <b>max. 1 A</b>	<b>AC eff. max. 4 A</b> <b>AC eff. max. 2 A</b> <b>AC eff.</b> DC <b>DC</b>	<b>at cos φ 1</b> <b>at cos φ 0,6</b> <b>min. 20 mA</b> min. 20 mA <b>max. 1 A</b>
Electrical connection	Plug connection for line sockets as per DIN EN 175 301-803, 3-pin, protection insulated without ground connection			
Degree of protection	<b>IP 54 as per IEC 529 (EN 60529)</b>			
Setting tolerance	<b>±15% switching point deviation referred to reference value, adjusted at pressure rises, vertical diaphragm position</b>			
<b>Deviation</b>	<b>Permissible deviation of the set value ≤ ± 15 % in the service life test according to EN 1854</b>			

**Definition of  $\Delta p$  switching difference**

The  $\Delta p$  switching difference is the pressure difference between the upper and lower switching pressure.

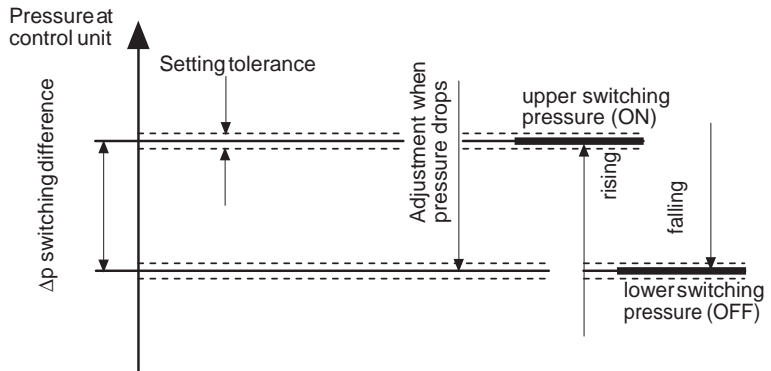

**Switching difference  $\Delta p$  @ GW...A5/A6**  
 Depending on the corresponding set value ( $p \downarrow$ )

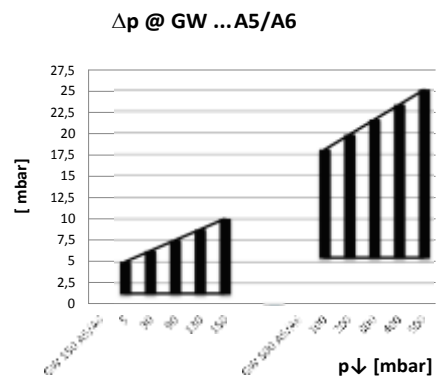
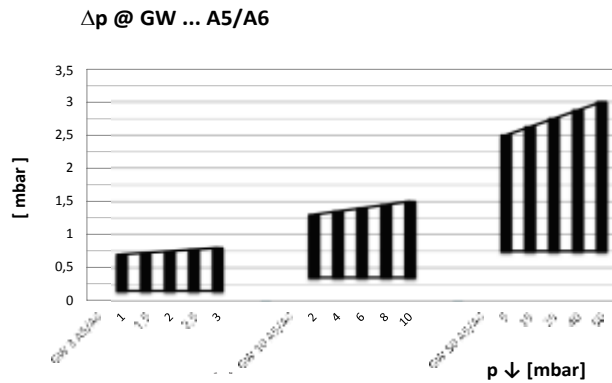

**Installation position**



Standard installation position; if different observe the change in switching point:

GW 3...50 A5 max.  $\pm 0,6$  mbar  
 GW 150 A5 max.  $\pm 1$  mbar  
 GW 500 A5 max.  $\pm 3$  mbar



In the horizontal installation position the switching pressure is increased.



When the pressure switch is mounted horizontally overhead, its switching pressure decreases.

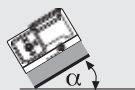

When the pressure switch is mounted in an intermediate position, its switching pressure deviates.

**Dimensions [mm]**

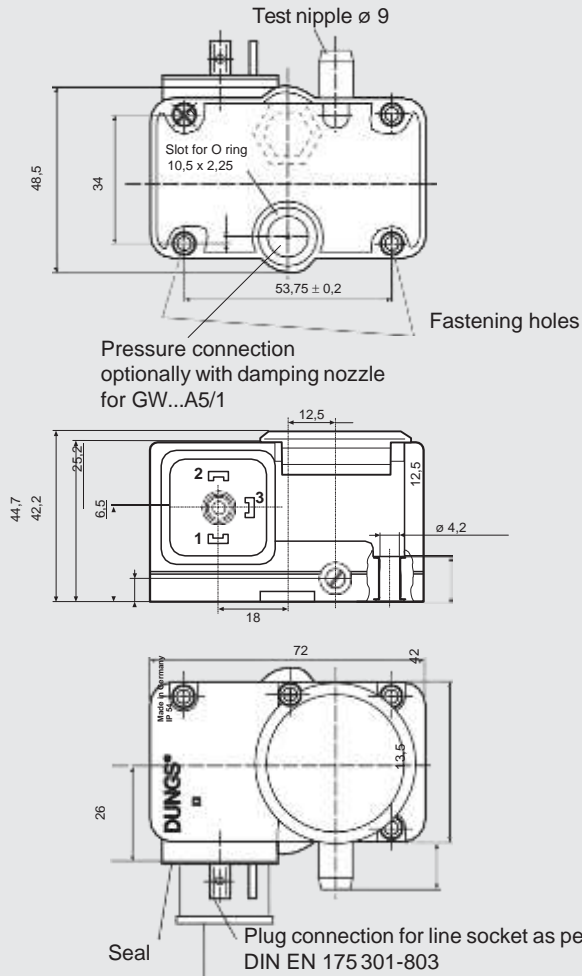

**Safety cover for plug-type connection**

**Designation**

**GW 150 A5 [Ag-G3-MS6-V12]**

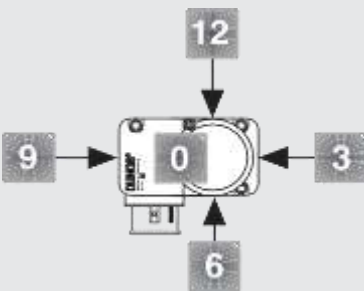

- Pressure connection**  
V12 Pressure connection G 1/4 position 12
- Test nipple**  
MS6 Test nipple at position 6
- Electrical connection**  
G3 Equipment connector, 3 pin protection-insulated, w/o grounding
- Contact material**  
Ag
- Setting**

**Order example**

**Pressure switch design**  
 Pressure Switch GW...A5  
**Setting range**  
**0,5 - 15 kPa (5 - 150 mbar)**  
**Contact material**  
 Ag  
**Electrical connection**  
 Equipment connector  
**Pressure connection**  
 At position 12  
**Test nipple**  
 MS 6

ranges	[kPa]	[mbar]
3	0,1 - 0,3	1 - 3
10	0,2 - 1	2 - 10
50	0,5 - 5	5 - 50
150	0,5-15	5 - 150
500	10,0-50	100 - 500

Pressure switch switches when **the setpoint is exceeded or undershot.**  
 GW...A5/1 Pressure switch with damping nozzle **switches on if the set reference value is exceeded or undershot**



**Brief technical data** 1 kPa = 10 mbar = 1000 Pa ≈ 100 mm WS

Type	Version [AG-G3-MS6-V12]	Order No.		Setting range	Switching difference Δp [mbar]				
		1 piece	100 pieces [mbar]		max.	p Èmin. p Èmax.			
GW...A5 pressure switch	GW 3 A5	<b>272 362</b>	—	1 - 3 ± 15 %	≤	<b>0,7</b>	≤	<b>0,8</b>	
	GW 10 A5	<b>272 350</b>	<b>225 938</b>	2 - 10 ± 15 %	≤	<b>1,3</b>	≤	<b>1,5</b>	
	GW 50 A5	<b>272 340</b>	<b>225 939</b>	5 - 50 ± 15 %	≤	<b>2,5</b>	≤	<b>3</b>	
	GW 150 A5	<b>272 339</b>	<b>225 940</b>	5 - 150 ± 15 %	≤	<b>5</b>	≤	<b>10</b>	
	GW 500 A5	<b>272 349</b>	<b>227 639</b>	100 - 500 ± 15 %	≤	<b>18</b>	≤	<b>25</b>	
with mounting kit									
GW...A5/1 pressure switch	GW 10 A5/1	<b>241 245</b>	—	2 - 10 ± 15 %	≤	<b>1,3</b>	≤	<b>1,5</b>	
	GW 50 A5/1	<b>241 246</b>	—	5 - 50 ± 15 %	≤	<b>2,5</b>	≤	<b>3</b>	
	GW 150 A5/1	<b>241 247</b>	—	5 - 150 ± 15 %	≤	<b>5</b>	≤	<b>10</b>	
	GW 500 A5/1	<b>241 248</b>	—	100 - 500 ± 15 %	≤	<b>18</b>	≤	<b>25</b>	
<b>with damping orifice and mounting kit</b>									

Accessories	Order-No.	for Type	Nominal diameters
<b>Mounting kit (2 x M4x20,1 x O-ring)</b>	223 280		
Adapter p <sub>Br</sub>	273 777	MB-D ...405 - 420 MB-Z ...405 - 420 DMV- ...503 - 520	Rp 3/8 - Rp 2 Rp 3/8 - Rp 2 Rp 3/8 - Rp 2
Adapter on <b>threaded flange (G 1/8)</b>	221 630	MB- ...405-412 DMV- ... SV- ...505-520	Rp 3/8 - Rp 1 1/4 Rp 3/8 - Rp 2
Adapter kit for GW ... A5 with G 1/4 connection	222 982	DMV- ... MB- ...415-420	Rp 3/8 - Rp 2
Special adapter on request		MB- ... DMV- ... MVD- ...	DN 40 - DN 125 Rp 3/8 - DN 150
Line socket 3-pin +E grey GDMW	210 318		