

Instruction Manual

For Gas Management & Control

Turbine Gas Meter

Built-in battery Type: TBX30, TBX100, TBX100F, TBX150F

External Power Source Type: TBX30D, TBX100D, TBX100FD, TBX150FD



TBX150F
(Built-in battery
type)

TBX30D
(External power
source type)

Thank you for purchasing this product.
Please read through this instruction manual carefully and use the product properly.
The warranty is on the back cover. Please review the content and keep it for future
reference.

Contents

<p>1 Indications used in this instruction manual1-2P</p> <p>2 Precautions for use2-3P</p> <p>3 For proper use.....3-4P</p> <p>4 Main body and structure.....5-6P</p> <p>5 Specifications7P</p> <p>6 External output8P</p> <p>7 Outside dimensions.....9P</p> <p>8 Service life.....9P</p> <p>9 External connection..... 10-11P</p>	<p>10 Instructions for installation and piping work 12-13P</p> <p>11 Functions 14-18P</p> <p>12 Instructions for the beginning of use ..19P</p> <p>13 Instructions for inspection.....19P</p> <p>14 Remote indicator (optional)20P</p> <p>15 Characteristic data (reference).....21P</p> <p>16 Troubleshooting22P</p> <p>17 Warranty and after-sales service contact information..... Back cover</p>
--	--

1 Indications used in this instruction manual

For proper use of the turbine gas meter for management and control, this instruction manual contains various pictograms intended to prevent injuries to you and other people or damage to property. Those pictograms and their meanings are listed below. Please understand the details before reading the body text.

Indication	Meaning	Page
Danger	Failure to follow this instruction may pose an imminent risk of death or serious injury of the user.	None
Warning	Failure to follow this instruction may pose a risk of death or serious injury of the user.	None
Caution	Failure to follow this instruction may pose a risk of injury of the user or damage to property.	2

The meanings of the pictograms are as follows:						
	General caution	Do not touch	General prohibition	Do not disassemble	No fire	Do
Pages	2•4•9•14•19	-	2•4	2	-	2•3•4

2 Precautions for use



Caution

1. Do not install the product at a dangerous place.



Do Not

Do not use the product for applications to which a high level of safety is required, such as nuclear power, railway, aviation, vehicle, and amusement applications. The electric circuits in this turbine meter do not have an anti-explosion structure.

2. Do not use this product for the measurement of corrosive gases or the gases listed below.



Do Not

It may corrode parts in use or cause a leakage of gas. In addition, the measurements can be inaccurate.

Toxic gases	Chlorine, hydrogen cyanide, nitrogen dioxide, fluorine
	Hydrogen chloride, boron trifluoride, boron dioxide
	Sulfur dioxide, hydrogen fluoride, hydrogen sulfide
Others	Ammonia, chlorine dioxide, oxygen, hydrogen, helium

Depending on the property of the gas to be measured, the meter may become deteriorated in performance or damaged. Contact us before measuring a special gas.

3. Do not give an impact to the meter.



Do Not

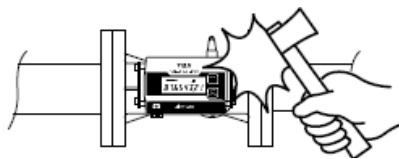

The meter is a precision measuring instrument. Do not give a strong impact to the meter or hit the meter with an object. Besides, do not insert a cylindrical object into the meter. It may cause a leakage of gas or damage.

4. Do not disassemble the meter.



Do not disassemble

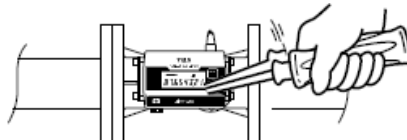

The meter is a precision measuring instrument. Do not disassemble it. It may cause a leakage of gas.

5. Conduct an airtightness test to the installed meter, including the pipes located prior and subsequent to it.



Do

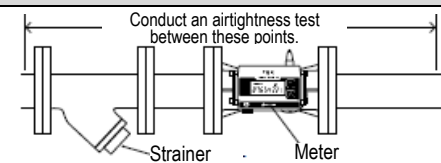

Check that no leakage occurs at a pressure 1.1 times larger than the maximum allowable working pressure.

6. Connection to an external power source (applicable for the external power source type)



Do

Use caution not to make a short circuit when connecting the external connection cable to a power source. The power source used should be an isolation type having a short-circuit protection function.

7. Disposal after use



Do

Never dispose of the meter through a general waste processing route because a lithium battery is embedded inside (applicable for the Built-in battery type).
Never throw the meter into a fire. It may ignite or explode.

3 For proper use

1. Be sure that the gas the customer is going to use agrees with the specifications shown on the nameplate.



Do

Model	Flow rate range	Output pulse unit Unit pulse [High-density pulse]	Date of manufacture	Serial number
MODEL	Range (m ³ /h)	Output A (L/p) [B (cm ³ /p)]	Date	Ser. No.
TBX100/L	10~100	10 [249.4]	'14-01	33721
Temp. -10~60°C Max. Pressure 100 kPa				Aichi tokei denki co., ltd.

2. The orientation markings on the main body of the meter must be the same as the direction of the gas flow.



Do

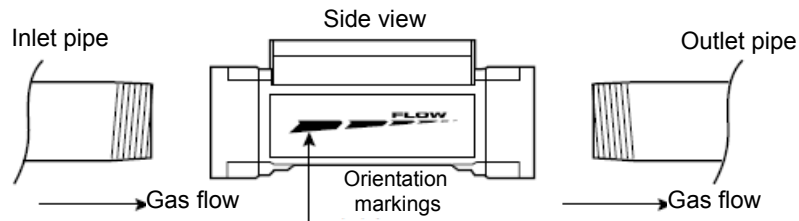

3. Straight pipes having a length of 10D (i.e. 10 times the pipe diameter) or greater must be provided prior and subsequent to the main body of the meter.



Do

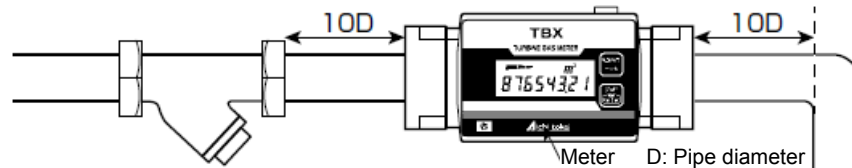

4. A strainer must be installed upstream from the meter.



Do

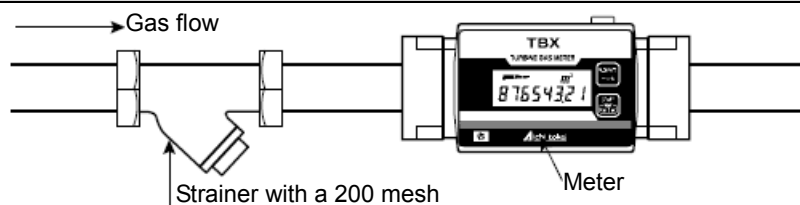

5. Do not install the meter at a place where oil mist or powder of dust is wafting.



1. Use the meter in a condition in which the generation of oil mist due to reliquefaction can be avoided. Oil mist that adheres to inside the flow rate meter may cause errors in flow rate measurement, hindering accurate measurement.

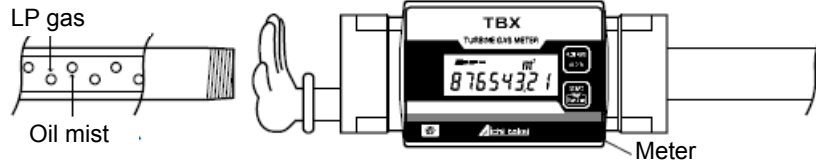

2. When the meter is used for a dry gas (e.g., 13A gas), the powder of dust (foreign particles) in the pipes may cause a failure in the rotating part, hindering accurate measurement.

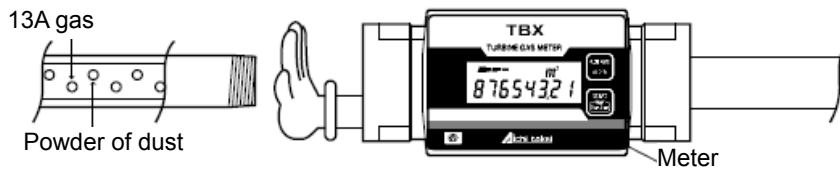

6. Do not tighten the flange-stuffing nuts too strong when installing the meter.

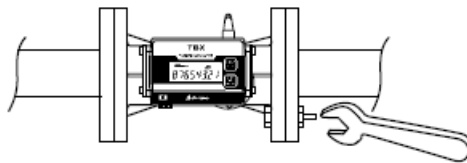

Fasten all the nuts softly before tighten them in an even, crisscross pattern (applicable for TBX100F (D) and TBX150F (D)).

Tightening torque	100 N·m max*
-------------------	--------------

- * Secure the minimum design fastening pressure recommended by the gasket manufacturer. Depending on the use conditions, the fastening torque may have to be controlled at a pressure exceeding the minimum design fastening pressure.

7. When connecting the meter to a counter pipe, align the centers.

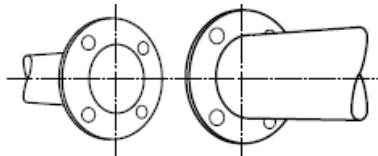

Use caution not to cause an eccentricity, inclination, or twist. Do not apply an excessive stress loading to the main body of the meter. (applicable for TBX100F (D) and TBX150F (D)).

8. When using newly installed pipes, purge the pipes for removing foreign objects before installing the meter.

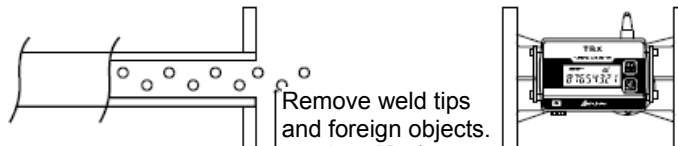

4 Main body and structure

1) Checking the content of the package





Check the following items when this product is delivered.

1. Check the model name to make sure it is the product you have ordered.
2. Check the appearance to make sure the product is not broken.
3. Verify the accessories with the specifications.

The accessories are listed in the following table.

After you have unpacked the product, great care should be taken not to lose or break the accessories.

Should your product have a defective or different item, contact your nearest branch office or sales office.

	Name or model	Appearance		Quantity	Remarks
		Built-in battery type	External power source type		
Standard items	Turbine meter main body			1	For the model name, refer to the item codes.
	External connection cable (6 wires, 5 m) TBXD-SS-BC	/		1	This cable cannot be used with an Built-in battery type product because of the difference in the number of contacts of the connector.
	Instruction manual			1	
Optional items	External connection cable (4 wires, 2 m) TBX-SS-B		/		This cable cannot be used with an external power source type product because of the difference in the number of contacts of the connector.
	Terminal box TBXD-SS-B	/		1	Ten pieces of round type crimp terminals (J.S.T. R1.25-3) are included.

2) Names of parts

Turbine meter main body

Integrated flow rate display
Instantaneous flow rate display
Trip flow rate display

* Switchable display
Pilot

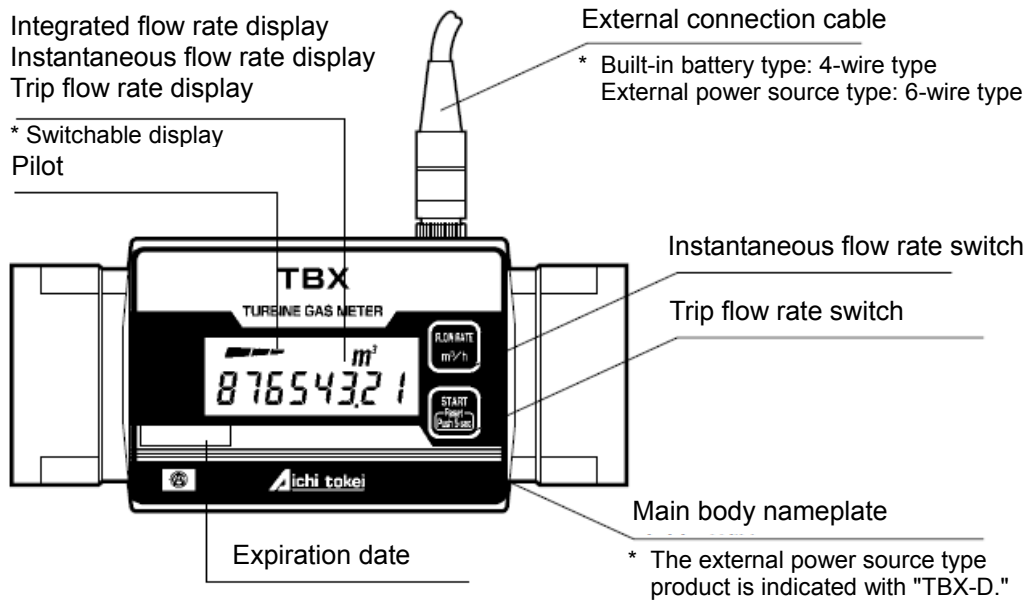

* The external power source type product is indicated with "TBX-D."

3) Item code

Basic type	Capacity	Connection type	Power source	/	Flow direction	Connection diameter	Description	
TBX	30						TBX	
							30 (Screw type only)	
							100 (Screw type and flange type)	
	100							150 (Flange type only)
								150 (Flange type only)
	150	Not indicated	F					Screw type
								Flange type
				Not indicated	D			Built-in battery type
								External power source type
					/			
						L		Left inlet (left to right)
						R		Right inlet (right to left)
					U		Bottom inlet (bottom to top)	
					D		Top inlet (top to bottom)	
							} TBX100F (D) only	
						3	32A (Rc 1 ¹ / ₄)	
						4	40A (Rc 1 ¹ / ₂)	
							} TBX30 (D) only	

5 Specifications

Model		TBX30(D)	TBX100(D)	TBX100F(D)	TBX150F(D)			
Flow rate range (m ³ /h)		4 – 30	10 – 100	10 – 100	12.5 – 150			
Maximum allowable working pressure (kPa)		100						
Withstanding pressure (kPa)		150						
Accuracy		± 1% FS						
Display	Integrated	LCD display: 8 digits Minimum readout value: 0.01 m ³		LCD display: 8 digits Minimum readout value: 0.1 m ³				
	Trip	LCD display: 6 digits Minimum readout value: 0.01 m ³		LCD display: 6 digits Minimum readout value: 0.1 m ³				
	Instantaneous	LCD display: 3 digits Minimum readout value: 0.1 m ³ /h	LCD display: 4 digits Minimum readout value: 0.1 m ³ /h		LCD display: 3 digits Minimum readout value: 1 m ³ /h			
Flow direction		Left inlet (L)	Right inlet (R)	Left inlet (L)	Right inlet (R)	Top and bottom, left and right (free)	Left inlet (L)	Right inlet (R)
Connection diameter		Rc 1 ¹ / ₄ , Rc 1 ¹ / ₂		Rc 2		JIS 10K Flange 50A		
Operating temperature range (°C)		-10 to +60						
Installation angle		Horizontal and vertical						
Measurable gas ^{*1}		City gas ^{*2} , LP gas ^{*2} , air, nitrogen						
Power source	Built-in battery type	Lithium battery						
	External power source type	12 to 24 VDC ±10%, supplied via the external connection cable, power consumption: 0.19 W max, current consumption: 7 mA ^{*3}						
Output signal		Open drain output 2 ch (unit pulse and high-density pulse)						
Installation location		Indoor						
Material		Aluminum allow			Cast iron		Aluminum allow	
Weight (kg)	Built-in battery type	Approx. 0.9		Approx. 1.6		Approx. 7.0		Approx. 2.5
	External power source type	Approx. 1.0		Approx. 1.7		Approx. 7.1		Approx. 2.6
Acquired standard	Built-in battery type (except for TBX100F)	EN 61000-6-4:2007+A1:2011 EN 61000-6-2:2005						

*1 Do not use corrosive gases. Refer to "Precautions for use" for details.

*2 Do not install the meter at a place where oil mist or powder of dust is wafting.

*3 Average value at the standard condition.

6 External output

This turbine meter is equipped with two open-drain outputs^{*1}.
To extract the outputs, use the dedicated external connection cable with a plug.

Standard specifications



Model		TBX30(D)	TBX100(D)	TBX100F(D)	TBX150F(D)
Unit pulse	Pulse output unit	10L/P			100L/P
	Pulse output width	40ms			
	Maximum ON current	20mA			
	Maximum ON resistance ^{*2}	50Ω			
	Maximum frequency ^{*3}	Approx. 0.8 Hz	Approx. 2.8 Hz		Approx. 0.4 Hz
High-density pulse	Pulse output unit	Approx. 110 cm ³ /p	Approx. 250 cm ³ /p		Approx. 470 cm ³ /p
	Minimum pulse output width	Approx. 13 ms	Approx. 9 ms		Approx. 11 ms
	Maximum ON current	10 mA			
	Maximum ON resistance ^{*2}	100 Ω			
	Maximum frequency	Approx. 75 Hz	Approx. 110 Hz		Approx. 90 Hz
Maximum applied voltage		24 VDC			

- *1 Unit pulse: A flow rate pulse after the unit matching by an arithmetic circuit
High-density pulse: A flow rate pulse that is output in synchronization with the rotation of the impeller
Duty ratio: 0.45 to 0.55 (at a constant flow rate)
- *2 The OFF resistant is 100 kΩ or more.
- *3 The maximum frequency with the standard specifications. The maximum frequency varies with the pulse output unit that has been set.
Note that the maximum frequency will be approximately 8 Hz when the pulse output unit of TBX30 (D) is set to 1 L/P.

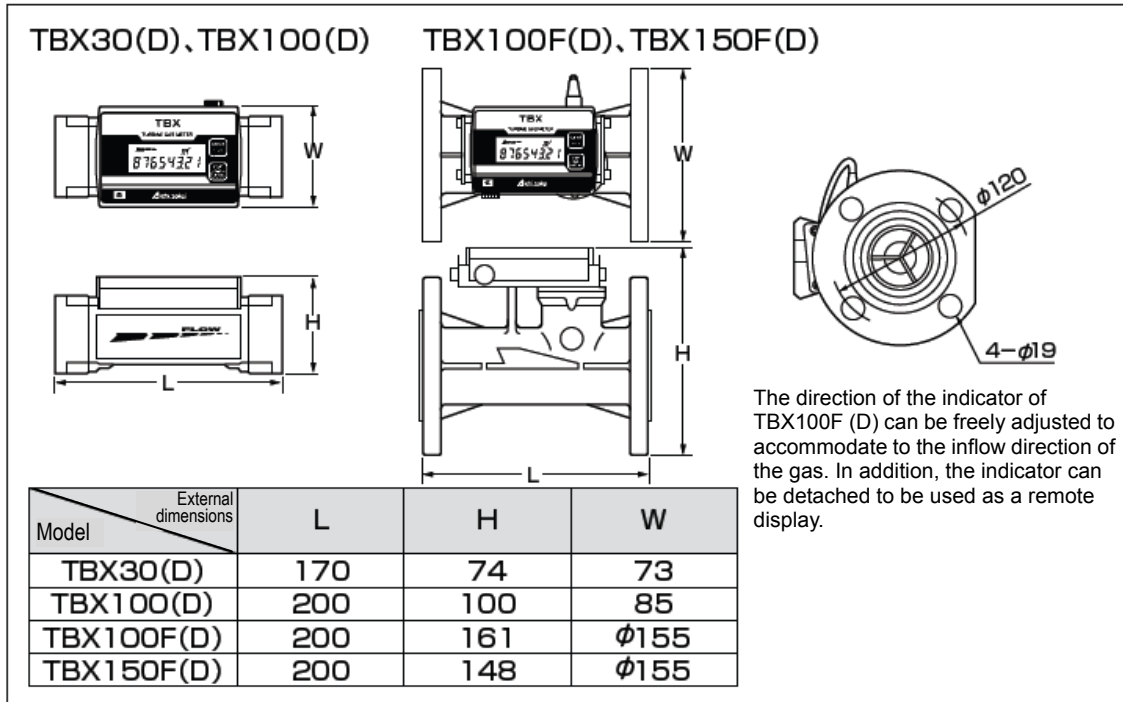
7 Outside dimensions



8 Service life

Name	Standard service life	Remarks
Turbine meter main body	7 years	 The service life could be shortened when oil mist or powder of dust flows into the pipes or when the meter is used continuously at a rate exceeding the maximum flow rate for a long time.
Lithium battery ^{*1}	7 years	 The battery life could be shortened when the meter is continuously used in high-temperature environments (approx. 60°C). The battery cannot be replaced.

*1 Applicable only for Built-in battery type products.
 When the remaining battery life becomes less than about one month, a running-down battery alarm function will be activated, in which the most significant digit of the integrated flow rate display blinks. (The duration until the rundown of the battery varies depending on the environment and the duration of use.)

9 External connection

- 1) Built-in battery type
 Use the dedicated external connection cable (optional) to extract the external pulse output signals (open drain).
 For the connection between the meter main body and the indicator, connect the signal wires of the indicator to the terminal box of the external connection cable (4 wires, 2 m) as follows.

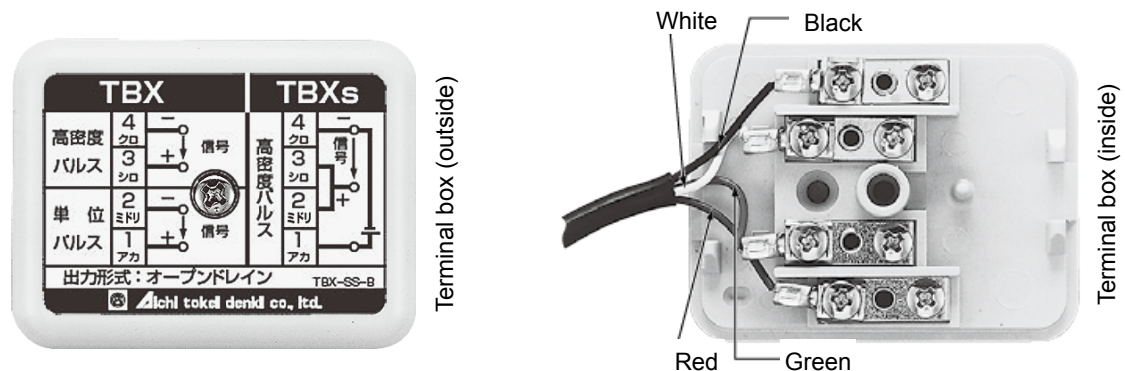
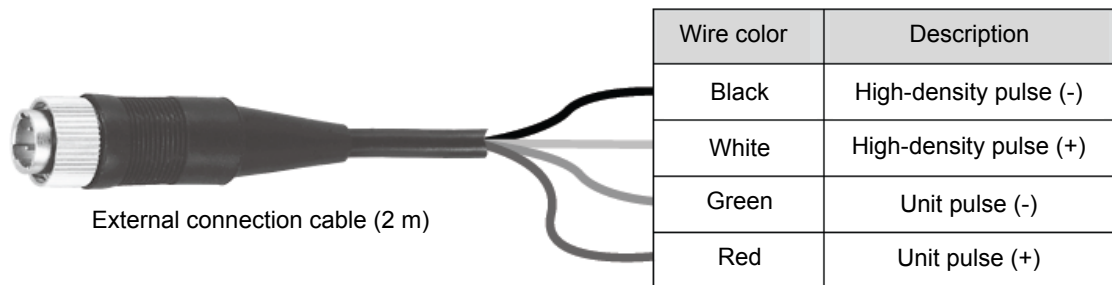

Standard specifications

Name	Specification
External connection cable	Heat resistance vinyl chloride 6 core shield wire UL20276SB AWG26 (4 cores are only used)
Terminal box	For indoor communication wires, 4 terminals

- 2) External power source type
 - External connection cable
 Use the dedicated external connection cable to supply a 12 to 24 VDC power and extract the external pulse output signals (open drain).
 For the connection between the meter main body and the indicator as well as a 12 to 24 VDC power source, connect the lead wires and power lines of the external connection cable (6 wires, 5 m) and the signal wires of the indicator as follows.

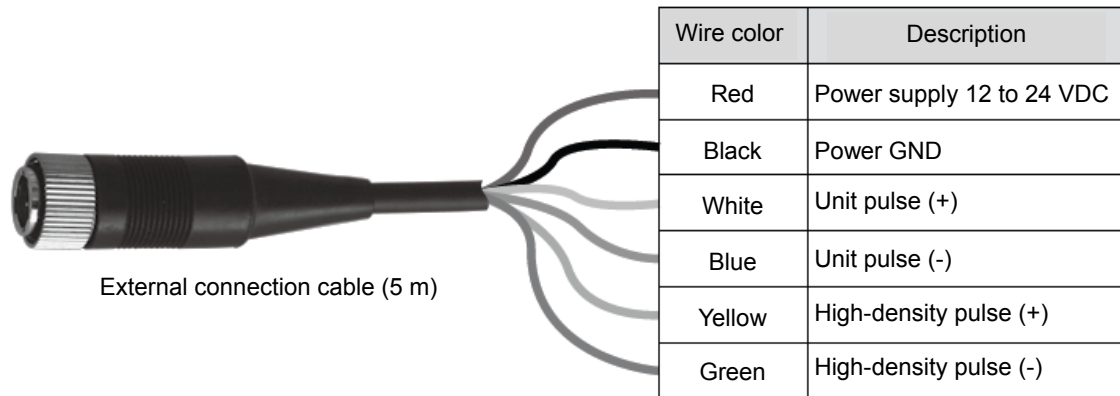

- Terminal box (optional)
The terminal box is used when the external connection cable and the indicator are connected indirectly.
Select and connect the power lines and output wires to be used, as necessary.



Terminal box (outside)

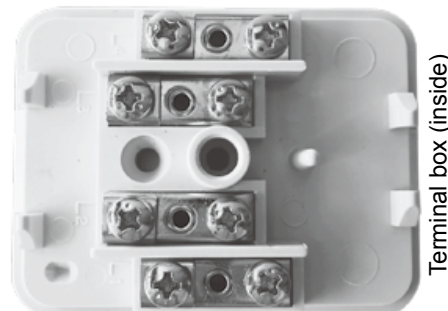

Standard specifications

Name	Specification
External connection cable	Oil-proof round PVC cord 0.2 mm ² x 6 wires
Terminal box	For indoor communication wires, 4 terminals

- Input/output circuit diagram
Be sure to interrupt the supply of external power while performing wiring.

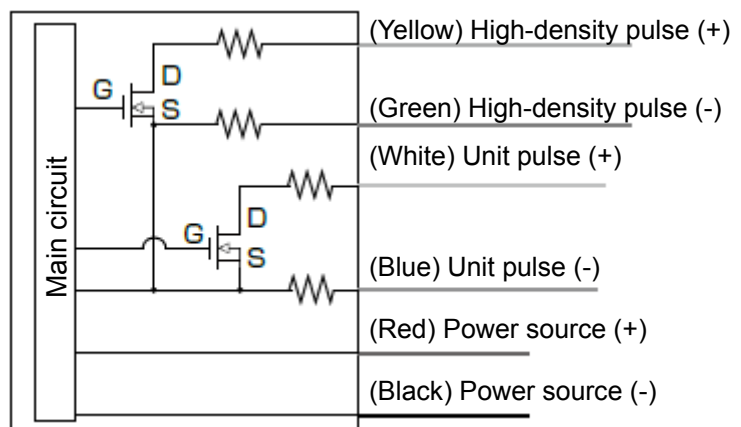

10 Instructions for installation and piping work

1. This turbine meter is designed for indoor installation. Install it at a place that is not splashed with rainwater.
2. This turbine meter can be used with both horizontal pipes and vertical pipes. Install it in the middle of a straight pipe section.
3. Do not install this turbine meter at a place where liquid such as oil or water may accumulate.
4. Install a strainer (200 mesh) upstream from this turbine meter (see page 3).
5. Do not install this turbine meter at a place where oil mist or powder of dust is wafting. It may cause a failure in the rotating part, hindering accurate measurement (see page 4).
6. Do not install this turbine meter to equipment that generates pulsatory motion, such as a gas engine. The measurement will be inaccurate.
7. Straight pipes having a length of 10D (i.e. 10 times the pipe diameter) or greater must be provided prior and subsequent to this turbine meter.
8. Use caution not to let foreign objects such as weld tips, foreign objects, and sealant enter during the installation of pipes.
9. Do not install this turbine meter at a place where it is subjected to an impact pressure.
10. Place noise sources, such as a control device of electromagnetic valves and power lines, one to two meters away from the meter main body and the external connection cable.
11. The direction of the indicator against the pipes is selectable.
12. Connect a 12 to 24 VDC power source when this turbine meter is the external power source type. On that occasion, use caution not to make a short circuit. The power source used should be an isolation type having a short-circuit protection function.

(1) In case of TBX30 (D)

- (1) On installation
Secure the connection unit first, and then screw pipes with tapered external threading into both ends of the meter.
- (2) On maintenance
 1. Remove the bolts (8 pcs.) located outside of the connection unit, and then you can take out the body perpendicular to the pipes.
 2. Replace the O ring with a new one, apply grease on it, and insert the meter to the pipes.

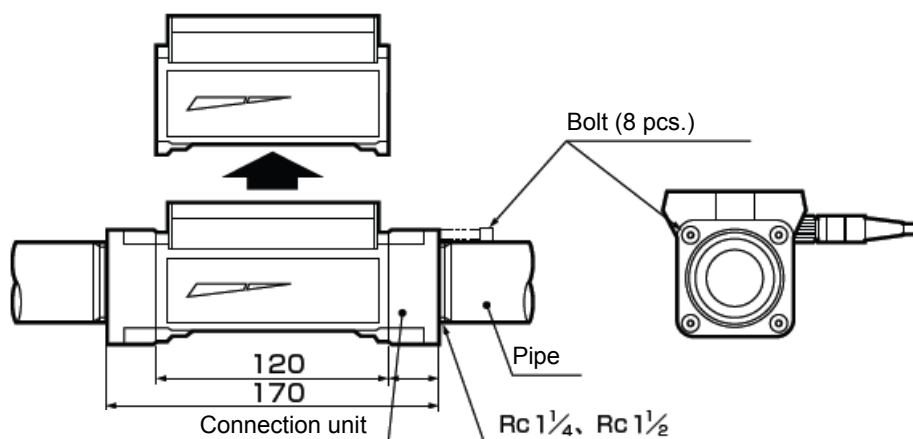

(2) In case of TBX100F (D)

The direction of the display of this product can be freely adjusted to accommodate to the inlet direction of the gas. In addition, the display can be detached to be used as a remote display.

1. Remove the "bolt with a hexagon hole" located at the side of the display.
2. A. Secure the mounting plate on a wall. (Use the attached screws.)
 B. Rotate the counter 180 degrees.
 C. Rotate the mounting plate 90 degrees to secure it. (Use the attached screws.)
3. Secure the counter again.
 The display can have an angle up to approximately 10 degrees.

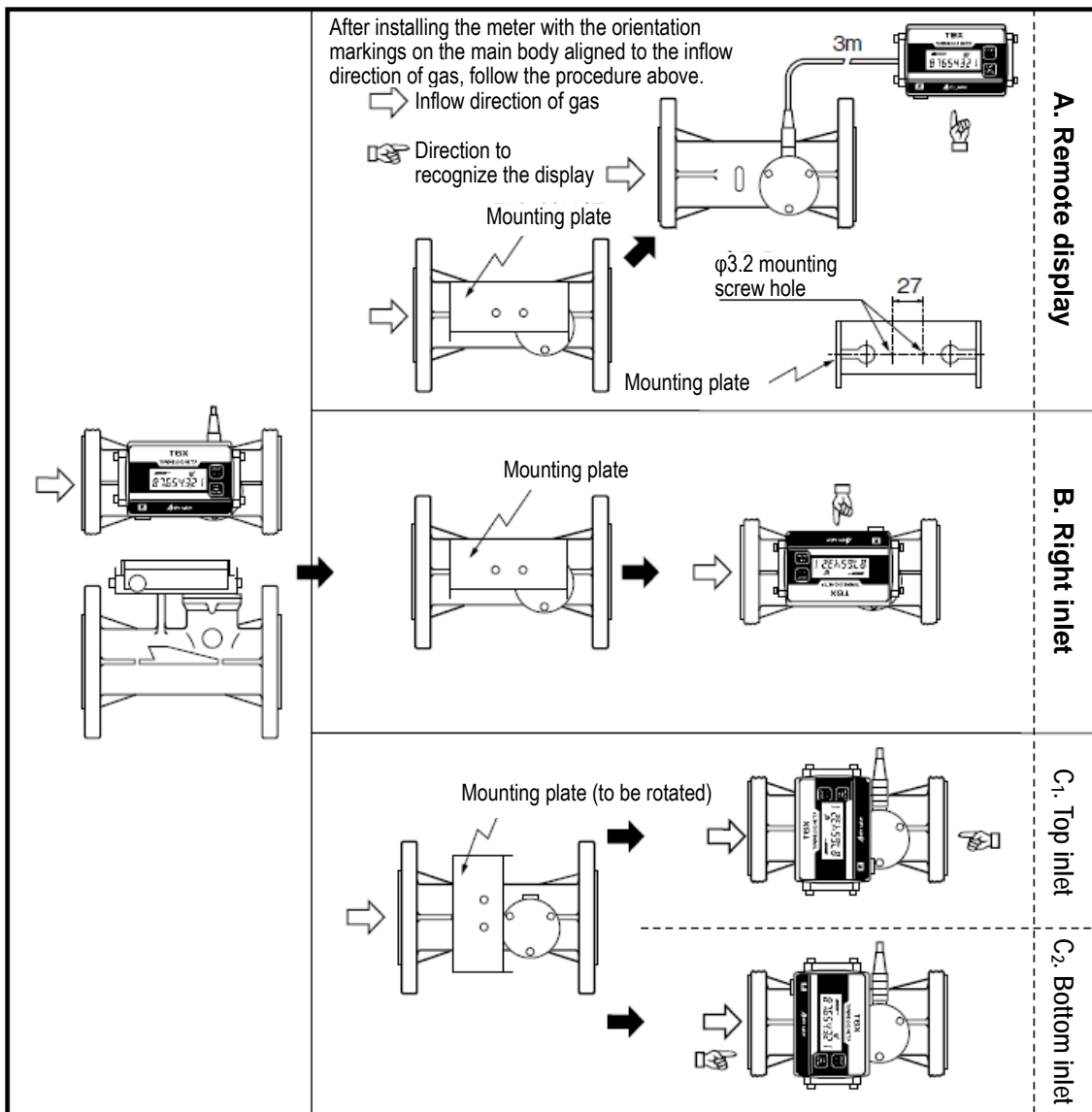

11 Functions



Caution

When operating the switches, be careful not to place firm pressure on them with a hard object such as a mechanical pencil and screwdriver because it may cause a failure of the switches. Press them with a soft object, such as the tip of a finger.

Normal mode and constant display mode

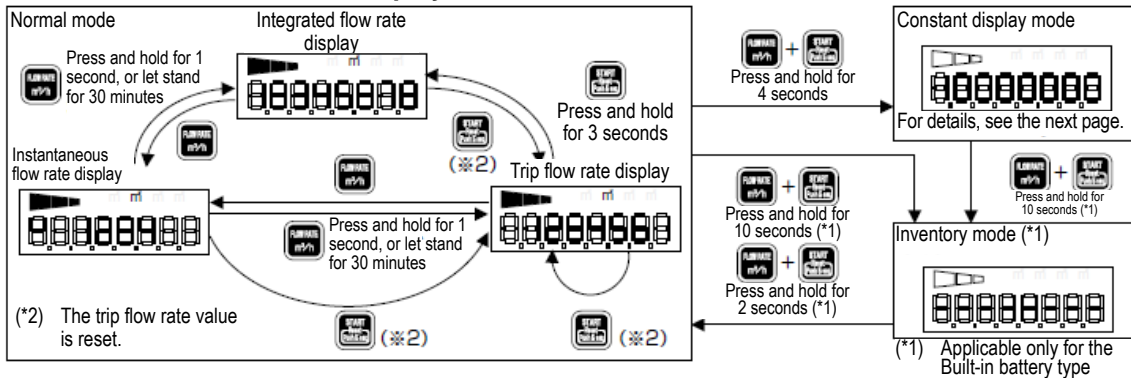

Category	Name	Model	TBX30 (D)	TBX100 (D) TBX100F (D)	TBX150F (D)
Switch part	Instantaneous flow rate switch		While an integrated flow rate value is displayed: Pressing the switch (for less than one second) will display an instantaneous flow rate value. Thirty seconds later, the display will automatically return to an integrated flow rate value. While an instantaneous flow rate value is displayed: Pressing and holding the switch (continuously for one second or longer) will change the display to the previous one prior to the latest switching (instantaneous flow rate display or trip flow rate display). When the display changes to a trip flow rate value, the value will not be reset. While a trip flow rate value is displayed: Pressing the switch (for less than one second) will display an instantaneous flow rate value. Thirty seconds later, the display will automatically return to a trip flow rate value.		
	Trip flow rate switch		While an integrated flow rate value or instantaneous flow rate value is displayed: Pressing the switch (for less than three seconds) will display an integrated flow rate value from the moment (trip flow rate). While a trip flow rate value is displayed: Pressing the switch (for less than three seconds) will reset the trip flow rate value. Pressing and holding the switch (continuously for three seconds or longer) will change the display to an integrated flow rate value.		
	Instantaneous flow rate switch + Trip flow rate switch		While an integrated flow rate value, instantaneous flow rate value, or trip flow rate value is displayed: Pressing and holding the switches together (continuously for four seconds or longer) will change the mode to the constant display mode. Pressing and holding the switches together (continuously for ten seconds or longer) will change the mode to the inventory mode. (*) Constant display mode: Pressing and holding the switches together (continuously for ten seconds or longer) will change the mode to the inventory mode. (*) For details, refer to 1) Constant display mode through 4) Pulse output setting conditions. Inventory mode (*) Pressing and holding the switches together (continuously for two seconds or longer) will change the display to an integrated flow rate value. For details, refer to 5) Inventory mode.		
Display part	Integrated flow rate (m ³)				
	Instantaneous flow rate (m ³ /h)				
	Trip flow rate (m ³)				
	Pilot		Blinking		Indicates that a gas is measured when it is flowing. The lamps repeatedly turn on from the left.

(*) Applicable only for the Built-in battery type

1) Constant display mode

During normal operation (while a flow rate value is displayed), pressing and holding the "FLOW RATE" switch and the "START" switch together for four seconds or longer will change the display to this mode.

You can select various setting items in sequence by pressing the "FLOW RATE" switch. Pressing the "FLOW RATE" switch for two seconds or longer at the item you want to set up (configurable constant only) allows you to set up the value.

Press the "FLOW RATE" switch to select the setting, and press and hold the "FLOW RATE" switch again for two seconds or longer to confirm the setting.

When the "START" switch is pressed or no switch operations have been done for ten seconds or longer during the selection of setting items, the display will return to an integrated flow rate value.

When no input operations have been done for ten seconds or longer during setting, the display will return to an integrated flow rate value even if the setting has not been completed.

When the setting has not been completed, the constant data to be used is the previous setting value.

The following figure shows the flow of constant setting and display.

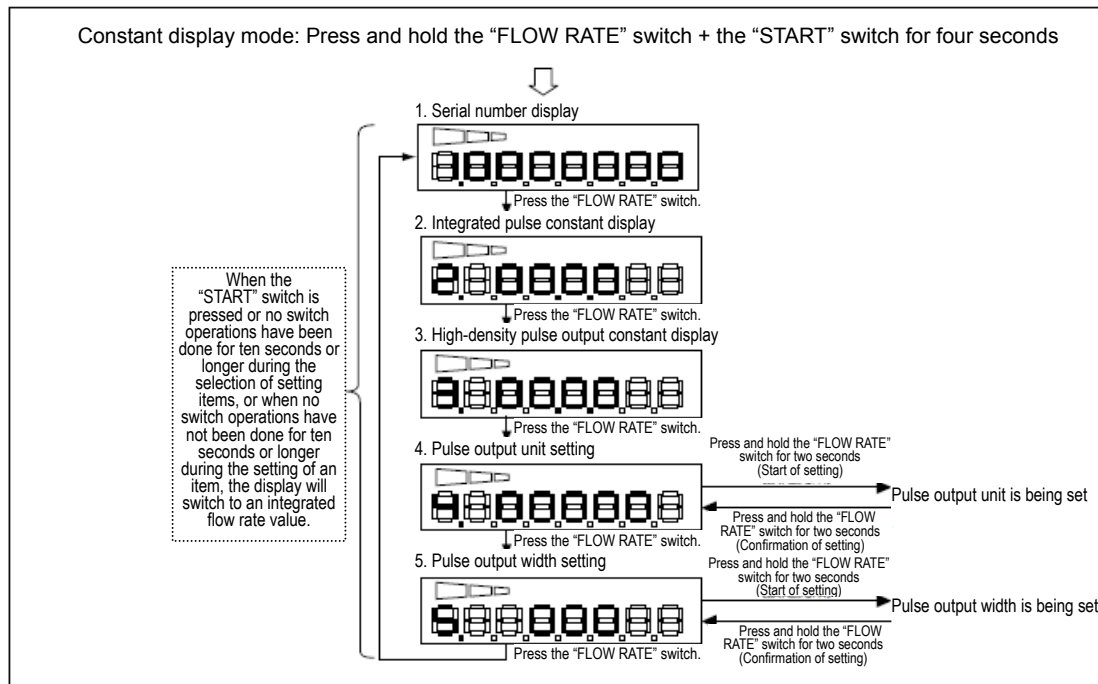

(2) Pulse output unit setting

Select the No.4 mode.

Pressing and holding the "FLOW RATE" switch for two seconds (i.e. start of setting) will make the setting value for pulse output unit blinking (0.5 seconds interval).

You can change the setting value for pulse output unit in the range from 1 to 10,000 L/P by pressing the "FLOW RATE" switch while the setting value is blinking (1 L/P, 10 L/P, 100 L/P, 1,000 L/P (1 m³/P), and 10,000 L/P (10 m³/P)).

After the setting has been completed, press and hold the "FLOW RATE" switch for two seconds (i.e. completion of setting) to confirm the setting value, and then the display will return to the item selection (current setting value display).

The following figure shows the overview of setting flow.

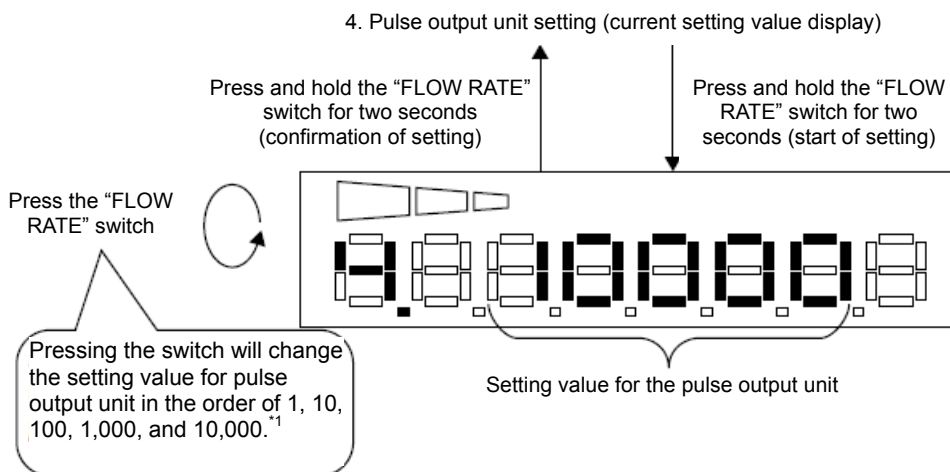

*1 Depending on the model, the restrictions specified in 4) Pulse output setting conditions are applied to the pulse output unit and the pulse output width.

3) Pulse output width setting

Select the No.5 mode.
 Pressing and holding the “FLOW RATE” switch for two seconds (i.e. start of setting) will make the setting value for output pulse width blinking (0.5 seconds interval).
 You can change the setting value for pulse output width between 40 and 120 in order by pressing the “FLOW RATE” switch while the setting value is blinking (40 ms and 120 ms). After the setting has been completed, press and hold the “FLOW RATE” switch for two seconds (i.e. completion of setting) to confirm the setting value, and then the display will return to the item selection (current setting value display).
 The following figure shows the overview of setting flow.

5. Pulse output width setting (current setting value display)

Press and hold the “FLOW RATE” switch for two seconds (confirmation of setting)

Press and hold the “FLOW RATE” switch for two seconds (start of setting)

Press the “FLOW RATE” switch

Pressing the switch will change the setting value for pulse output width between 40 and 120.*1

Setting value for pulse output width

*1 Depending on the model, the restrictions specified in 4) Pulse output setting conditions are applied to the pulse output unit and the pulse output width.

4) Pulse output setting conditions

Model	Pulse output unit	Pulse output width	Configuration allowed/not allowed	Model	Pulse output unit	Pulse output width	Configuration allowed/not allowed	Model	Pulse output unit	Pulse output width	Configuration allowed/not allowed
TBX30(D)	1L/P	40ms	○(Allowed)	TBX100(D) TBX100F(D)	1L/P	40ms	x (Not allowed)	TBX150F(D)	1L/P	40ms	x (Not allowed)
		120ms	x (Not allowed)			120ms	x (Not allowed)			120ms	x (Not allowed)
	10L/P	40ms	○(Allowed)		10L/P	40ms	○(Allowed)		10L/P	40ms	○(Allowed)
		120ms	○(Allowed)			120ms	○(Allowed)			120ms	x (Not allowed)
	100L/P	40ms	○(Allowed)		100L/P	40ms	○(Allowed)		100L/P	40ms	○(Allowed)
		120ms	○(Allowed)			120ms	○(Allowed)			120ms	○(Allowed)
	1000L/P (1m³/P)	40ms	○(Allowed)		1000L/P (1m³/P)	40ms	○(Allowed)		1000L/P (1m³/P)	40ms	○(Allowed)
		120ms	○(Allowed)			120ms	○(Allowed)			120ms	○(Allowed)
	10000L/P (10m³/P)	40ms	○(Allowed)		10000L/P (10m³/P)	40ms	○(Allowed)		10000L/P (10m³/P)	40ms	○(Allowed)
		120ms	○(Allowed)			120ms	○(Allowed)			120ms	○(Allowed)

5) Inventory mode (applicable only for the Built-in battery type)

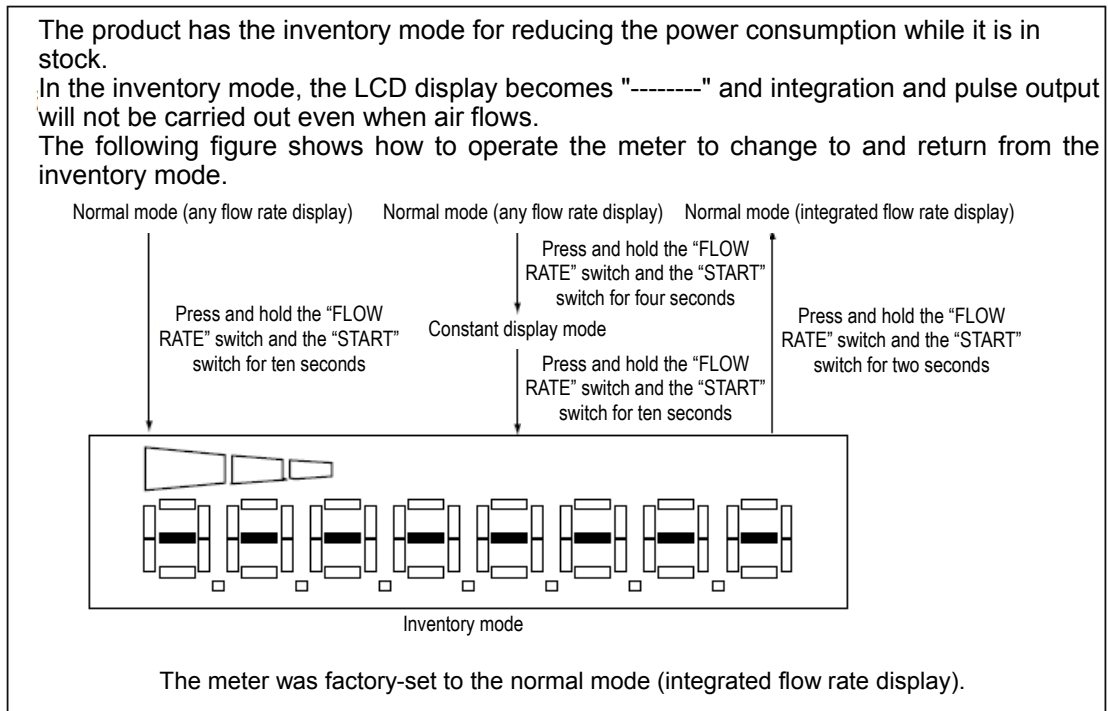

6) Behavior when a power failure occurs (applicable only for the external power source type)

- 1) Power failure detection
When the power source voltage decreases to 8.9 ± 0.5 V or less, the meter recognizes the occurrence of a power failure and then turns off the LCD display and suspends measurement.
The meter also saves the integrated flow rate and trip flow rate values immediately before the detection.
- 2) Power failure recovery
When the power source voltage increases to 9.4 ± 0.7 V or more, the meter recognizes the recovery of a power failure and then turns on the LCD display and resumes measurement.
The integrated flow rate value immediately before the detection of the power failure is restored, and the integration is resumed from that value.

12 Instructions for the beginning of use

1. Open the inflow valve (upstream from the meter) gradually.
2. Open the outflow valve (downstream from the meter) gradually.
Check that the pilot is blinking.
3. Change the indicator display of the meter to an instantaneous flow rate value, and then adjust the valve so that the flow rate value is in the specified range.
4. Use the meter in the normal mode with the integrated flow rate display.
5. At the time of power-on (applicable only for the external power source type), an integrated flow rate value is displayed.

13 Instructions for inspection



Depending on the gas to be measured, installation environment, and use conditions, the performance of the meter can rapidly deteriorate. Periodically check the meter at the appropriate times in accordance with your usage conditions.

1. When the pilot does not blink in spite of the presence of a gas flow, detach the meter from the pipes and then gently blow air into the inlet of the meter to check whether or not the pilot on the indicator blinks. If the pilot does not blink, check whether or not foreign objects adhere to inside the meter. Remove such objects as necessary.
 - a. Foreign objects on the rim of the impeller can be removed by giving a light impact on the body.
 - b. Due to the structural restrictions, it would not be possible to restore a meter that has an adherent such as sealant that cannot be removed on-site. In such a case, you will need to purchase a new one (i.e. the meter is not repairable).
2. If the foreign objects can be removed, blow air into the inlet again. When the pilot blinks, the meter is now properly working.
3. When the most significant digit of the integrated flow rate display is blinking, it is warning that the battery is running down (applicable only for the Built-in battery type). It is recommended that the meter should be replaced immediately.

14 Remote indicator (optional)

1) Types of remote indicators

Model	Functions	Power source
ZC09-96	Instantaneous flow rate display, integrated flow rate display, pulse output	Embedded battery
ZX-564	Instantaneous flow rate display, integrated flow rate display, pulse output, analog output, alarm output	85 to 264 VAC (free power source)
RE101	Recorder	Selectable from 100 VAC, 200 VAC, and 24 VDC

2) Connection diagram of the remote indicator (example)

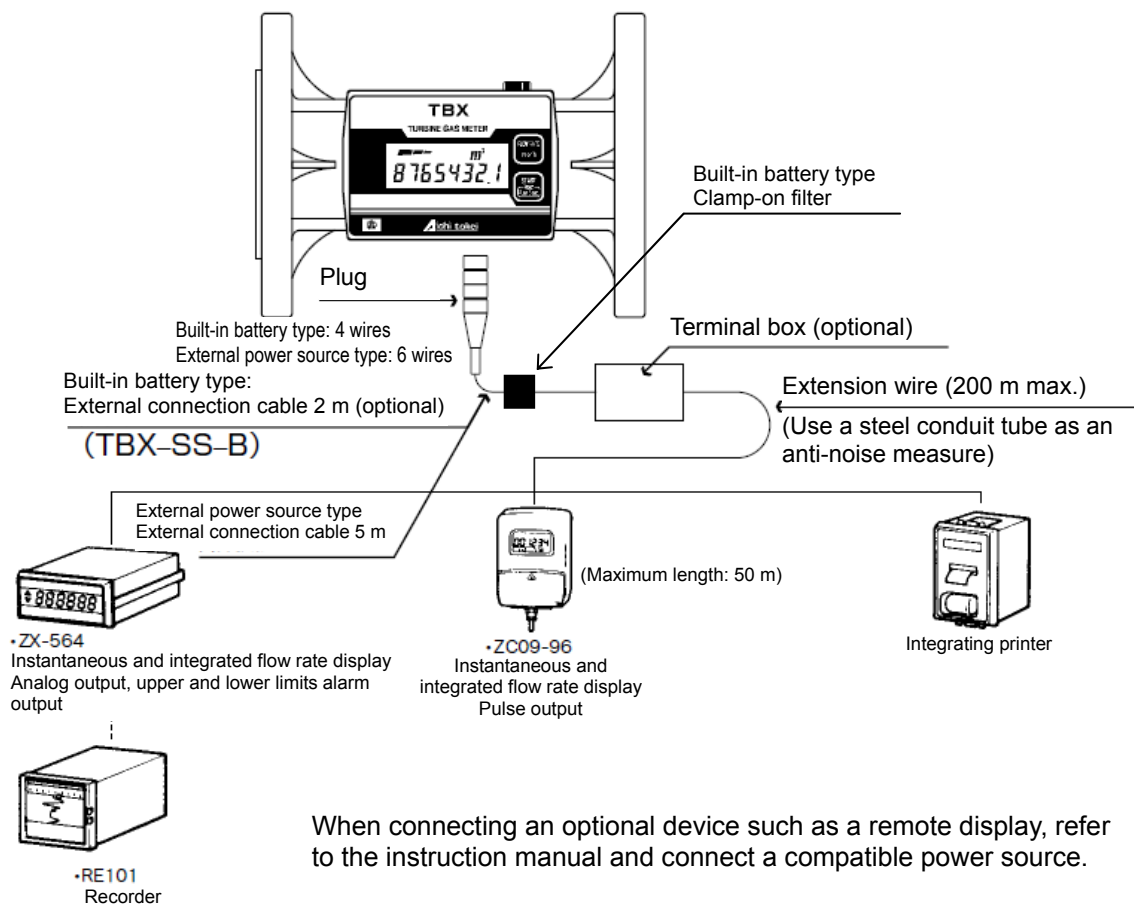

15 Characteristic data (reference)

Turbine meter TBX30 (D) general performance diagram (low-pressure air)

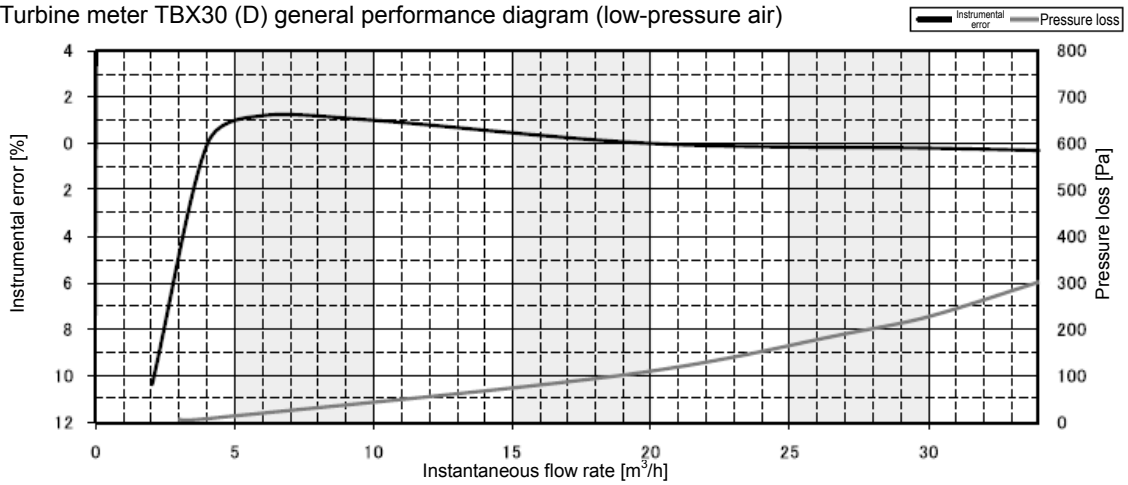

Turbine meter TBX100 (D), TBX100F (D) general performance diagram (low-pressure air)

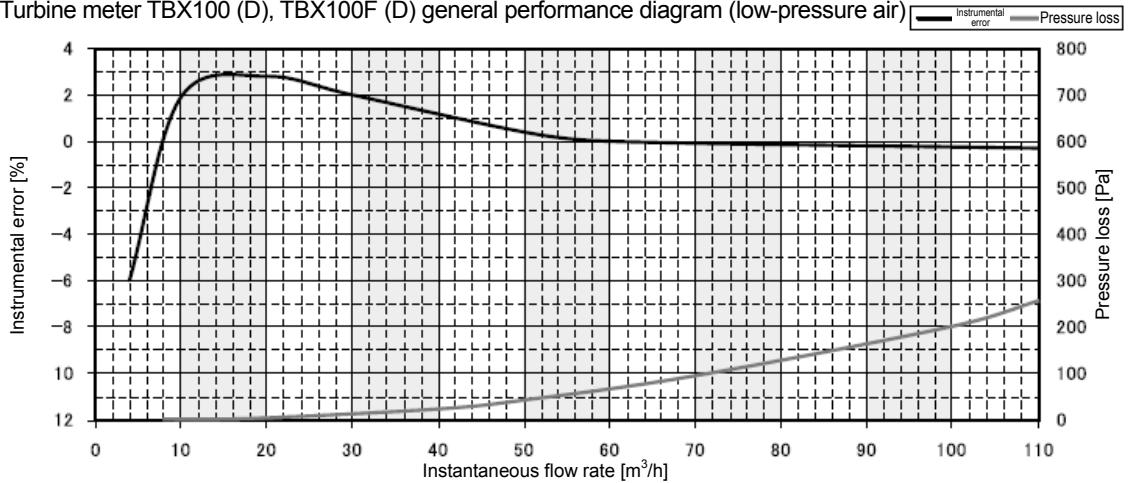

Turbine meter TBX150 (D) general performance diagram (low-pressure air)

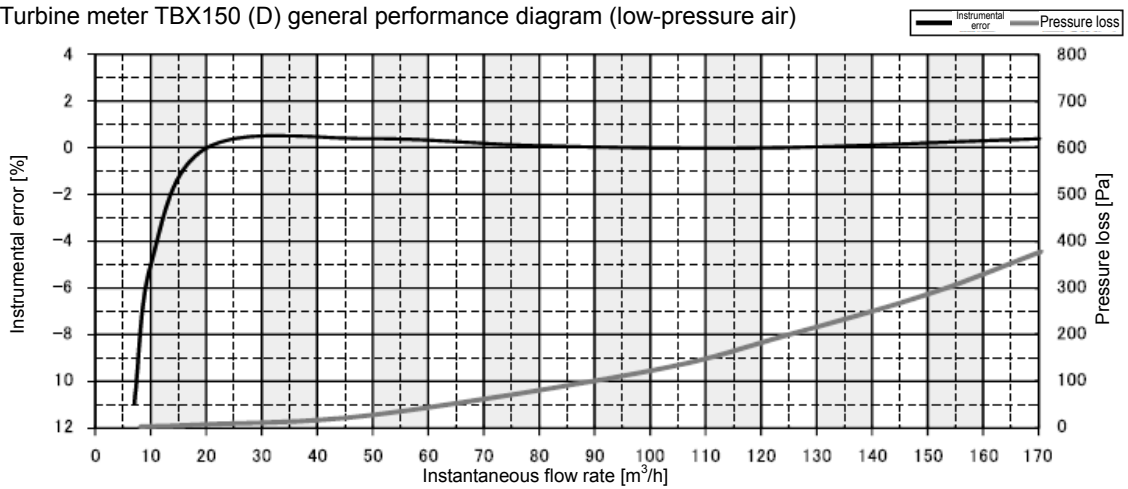

16 Troubleshooting

In the event you encounter a trouble that could be caused by a failure of the meter, refer to the following table first. If the symptom is not listed in this table or the measures in this table does not improve the situation, contact your nearest branch office or sales office.

Symptoms	Possible causes	Corrective actions
No pulse is output.	The external connection cable was wrongly wired.	Check that the pulse outputs (unit pulse/high-density pulse) are properly connected in the correct polarity. Refer to Chapter 9, External connection for how to connect the cable.
	The external connection cable has broken.	Repair the broken part, or replace the external connection cable.
	The connector part of the external connection cable has broken because its sheathed part was rotated during the connection/disconnection of the connector.	Be sure to rotate the metal ring at the tip of the connector. Since the connector part has broken, the external connection cable has to be replaced.
The display turns off.	The external connection cable was wrongly wired (applicable only for the external power source type).	Check that the power source is correct in voltage and polarity. Refer to Chapter 9, External connection for how to connect the cable.
	The external connection cable has broken (applicable only for the external power source type).	Repair the broken part, or replace the external connection cable.
	The circuit board became moist due to rainwater or other liquid, which led to a short circuit.	This product is not a waterproof design. Be careful not to let water get into the display.
	Due to a lightning-induced impulse, an overvoltage was applied to the internal circuit board, which caused a breakdown in the circuit board.	Since the internal circuit board has a failure, the meter main body has to be replaced.
	The most significant digit of the integrated flow rate display is blinking.	The voltage of the battery has reduced (applicable only for the Built-in battery type). The blink indicates that the battery is running down. The meter body has to be replaced.
	The display cannot be changed with a switch.	The switch has broken down because firm pressure was placed on it with a hard object such as a mechanical pencil and screwdriver. The circuit board became moist due to rainwater or other liquid, which led to a short circuit and caused the microcomputer to malfunction.
The integrated flow rate value is increasing in spite of the absence of a gas flow.	Noises incoming from the external connection cable caused the microcomputer to malfunction.	Place the meter away from other signal wires. Use a shielded wire as the extension wire to the remote indicator. In addition, install a pulse converter to isolate the transmitter circuit and the receiver circuit.
<ul style="list-style-type: none"> - The integrated flow rate value does not increase. - The flow rate of the meter main body is smaller than the actual flow rate. 	The meter is being used out of the specified flow rate range, so that the actual flow rate cannot be measured correctly.	Use the meter main body in the specified flow rate range.
	The impeller cannot rotate correctly because a foreign object has adhered to the impeller.	Following Chapter 13, Instructions for inspection, inspect the meter main body and remove the foreign object. In addition, clean the inside of the pipes and install a strainer upstream from the meter main body.
	The impeller cannot rotate correctly because a foreign object in a pipe has got into the bearing.	
	The impeller cannot rotate correctly because drain or water has got into the bearing.	The meter cannot be installed where drain or water is supplied.

Warranty of the turbine gas meter for management and control

Base model names: TBX30, TBX100, TBX100F, TBX150F, TBX30D, TBX100D, TBX100FD, TBX150FD

This product has been delivered through strict quality control and close inspection. This warranty is to assure that this product will be replaced at no charge on the basis of the conditions described in this warranty, in the event that this product goes out of order under the customer's normal use conditions.

Note

1. The warranty period is one year from the date of purchase, and the warranty covers only the main body. In the event that a failure occurs during the warranty period, contact us presenting this warranty.
2. This warranty will not be reissued. Retain it in a safe place.
3. Refer to the following for the provisions of this warranty.

Provisions for free-of-charge replacement

1. Aichi Tokei Denki will replace the product at no charge in the event that it goes out of order within one year under normal use conditions in accordance with the directions in the instruction manual.
2. This warranty must be presented when you have the product that has gone out of order within the warranty period replaced at no charge.
3. Even in the warranty period, the following cases will not be covered by the warranty.
 - 1) Malfunction or damage due to an error in use or an illegal adaption
 - 2) Malfunction or damage due to the relocation of the mounting position, impact, or falling after the purchase
 - 3) Malfunction or damage due to a human-made disaster; flood damage, earthquake, lightening, or other natural disaster; pollution, or abnormal voltage
 - 4) Lack of presentation of this warranty
 - 5) Malfunction or damage due to the use of a gas out of specification
4. This warranty is valid only in Japan.

Date of purchase	___ / ___	
Name of the customer		
Address		
Fill in the columns based on the nameplate.	Model	
	Serial	
Name of the gas used		

Dear customer,
Please fill in the date of purchase, name, address, model, serial number, and name of the gas used when you receive this warranty.



Aichi tokei denki co., ltd.

1-2-70 Chitose, Atsuta-ku, Nagoya, 456-8691, JAPAN
URL: <http://www.aichitokei.co.jp>

Contact us at your nearest branch office or business office.

Sapporo Branch Office	TEL (011)642-9500	Nagoya Branch Office	TEL (052)661-5852	Miyazaki Satellite Office	TEL (0985)24-2279
Kushiro Sales Office	TEL (0154)23-7859	Kanazawa Sales Office	TEL (076)252-1942	Okinawa Satellite Office	TEL (098)860-9792
Sendai Branch Office	TEL (022)258-1181	Shizuoka Sales Office	TEL (054)237-7168	Overseas Sales Headquarters	TEL (052)661-5150
Aomori Sales Office	TEL (017)742-6771	Nagano Satellite Office	TEL (026)254-5677		
Morioka Sales Office	TEL (019)646-8836	Osaka Branch Office	TEL (06)6305-9052		
Tokyo Branch Office	TEL (03)3209-0631	Hiroshima Sales Office	TEL (082)292-8289		
Yokohama Sales Office	TEL (045)661-1491	Takamatsu Sales Office	TEL (087)851-6664		
Chiba Sales Office	TEL (03)5658-1320	Okayama Sales Office	TEL (086)207-6828		
Omiya Sales Office	TEL (048)668-0131	Fukuoka Branch Office	TEL (092)534-2050		
Niigata Satellite Office	TEL (025)282-5591	Kagoshima Sales Office	TEL (099)254-7877		



Preservation bag

Revised 18.04
