

FE515

Low-pressure gas regulator



TECHNICAL BROCHURE

Pietro Fiorentini S.p.A.

Via E.Fermi, 8/10 | 36057 Arcugnano, Italy | +39 0444 968 511
sales@fiorentini.com

The data contained in this document are not binding.
Pietro Fiorentini reserves the right to make changes without prior notice.

fe515_technicalbrochure_AUS_revB

www.f Fiorentini.com

Who we are

We are an international company specialising in the design and manufacture of cutting-edge devices and solutions for natural gas processing, transport and distribution systems. We are the ideal partner for operators in the Oil & Gas sector, with a business offer that goes across the whole natural gas chain.

We are in constant evolution to meet our customers' highest expectations in terms of quality and reliability.

Our aim is to be a step ahead of the competition, with customized technologies and an after-sale service program undertaken with the highest grade of professionalism.



Pietro Fiorentini advantages



Localised technical support



Experience since 1940



We operate in over 100 countries

Application area

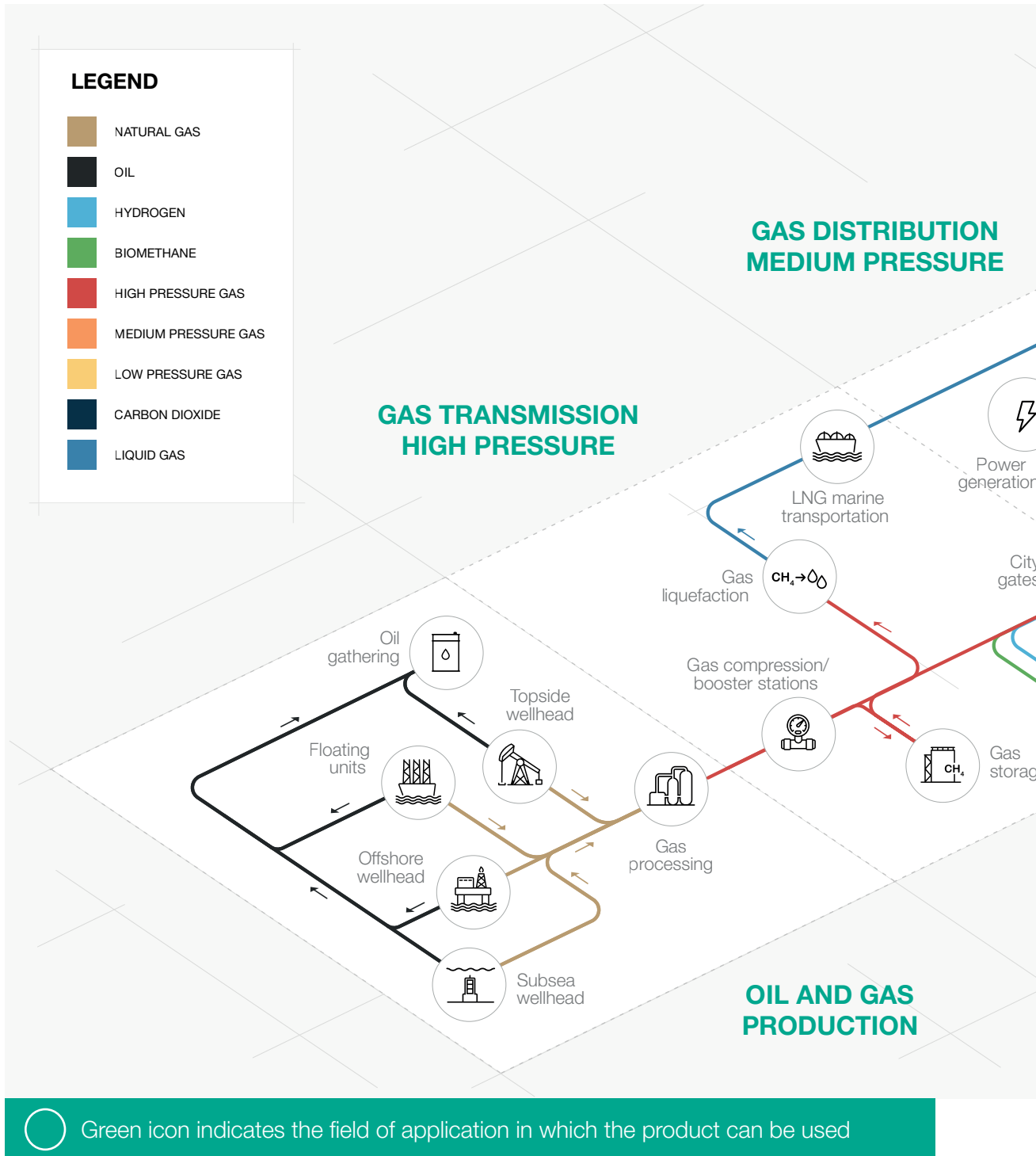

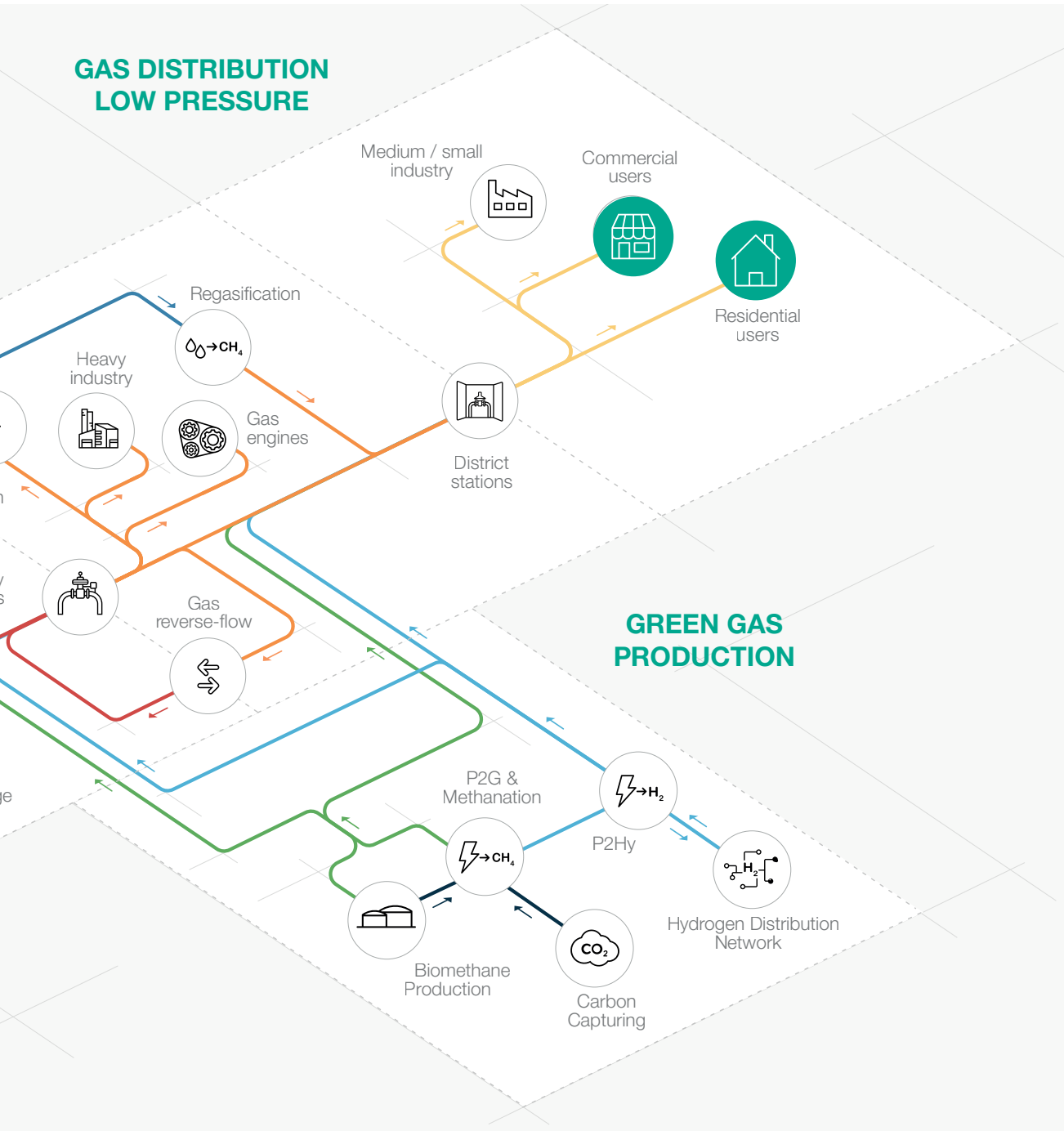

Figure 1 Map of application areas



Introduction

FE515 is a two-stage spring loaded lever operated gas pressure regulator by Pietro Fiorentini.

It is particularly suitable for low pressure natural gas distribution networks for residential and commercial users.

It should be used with previously filtered non-corrosive Natural Gas or LPG.

According to the European Standard EN 334, it is classified as Fail Close since always supplied with an overpressure protection device (slam shut valve).

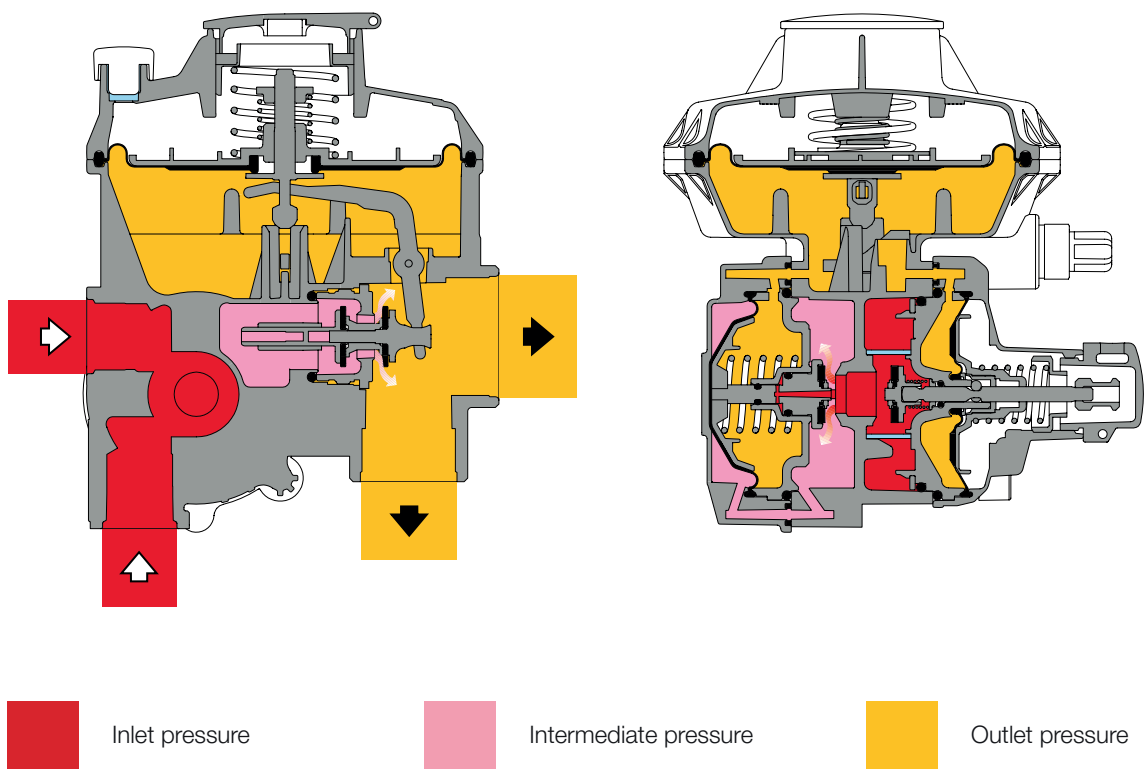

Figure 2 FE515

Features and Calibration ranges

The FE515 is a two-stage device for low pressure equipped with integrated slam shut (OPSO), and optional excess flow valve (EFV) which enable UPSO feature and fire protection valve.

The balanced 1st stage regulation limits the pressure variation to the 2nd stage, so it is possible to reach high accuracy of the regulated outlet pressure. Therefore, a balanced double stage regulator has a single-size orifice for all pressure and flow conditions.

The FE515 can be installed in vertical or horizontal position and has one in-line or 90° inlet and two outlets. This reduces greatly space requirements for all types of installations.

The FE515 regulator is highly customizable in terms of settings, fittings and accessories.



Figure 3 FE515

FE515 competitive advantages



Operates with low differential pressure



Built-in filter



Slam-shut valve for overpressure



Excess flow valve option which enable UPSO



Two-stage regulation with balanced first stage plug



Suitable for outdoor installations



High customisation



Integrated thermal valve option

Features

Features	Values		
Design pressure* (PS ¹ / DP ²)	0.515 MPa 5.15 bar		
Inlet pressure (MAOP / p _{umax} ¹)	10 - 515 kPa 0.1 - 5.15 bar		
Nominal capacity	6 - 25 m ³ /h 212 - 875 ft ³ /h		
	BP version	TR version	
Range of downstream pressure Wds	1.3 - 18 KPa 13 - 180 mbar	18.1 - 50 KPa 181 - 500 mbar	
Range of downstream pressure Wdso	2.5 - 30 kPa 25 - 300 mbar	30 - 80 kPa 300 - 800 mbar	
Accuracy class (AC)	10		
Lock-up over pressure (SG)	20		
	Standard version	Extended temperature version	Arctic version
Ambient temperature* (TS ¹)**	from -20 °C to +60 °C from -4 °F to +140 °F	from -30°C to + 60°C from -22 °F to +140 °F	from -40°C to + 60°C from -40 °F to +140 °F
Inlet gas temperature* ^{***}	from -10°C to + 60°C from +14 °F to +140 °F	from -20°C to + 60°C from -4 °F to +140 °F	from -30 °C to +60 °C from -22 °F to +140 °F
Body connection	Inlet G 1/2" and outlet G 1" or G 3/4" according to ISO 228/1, other configurations or connections on request		
Fittings	<ul style="list-style-type: none"> Gas (as per UNI EN ISO 228-1:2003); Flat swivel joint (as per NF E29-533: 2014 and NF E29-536: 2017); NPT (according to ASME B1.20.1, excluding connections with metal/metal sealing); 		
<p>(¹) according to EN334 standard (²) according to ISO 23555-1 standard (*) NOTE: Different functional features and/or extended temperature ranges may be available on request. Stated inlet gas temperature range is the maximum for which the equipment's full performance, including accuracy is guaranteed. Product may have a different pressure or temperature ranges according to the version and/or installed accessories. (***) NOTE: Stated temperature range is the operating range for which the equipment's mechanical resistance and leakage rate are guaranteed. Some body materials, if multiple choices are available, may not be suitable for all the available versions shown. (***) NOTE: Stated temperature range is the range for which the equipment's full performance, including accuracy and lock-up are guaranteed. Some body materials, if multiple choices are available, may not be suitable for all the available versions shown.</p>			

Table 1 Features

Materials and Approvals

Part	Material
Diaphragm and seats	Nitrile rubber for BP version Rubberized fabric for TR version
Sealing rings	Nitrile
Body and cover	Zamak
Seat	Zamak

NOTE: The materials indicated above refer to the standard models. Different materials can be provided according to specific needs.

Table 2 Materials

Construction Standards and Approvals

The **FE515** regulator is designed in compliance with European standard EN 13611.

Based on the version/configuration, the FE515 regulator complies with:



EN 13611



UNI 8827



EN 16129



EN 88-2



UNI 11655



Maximum allowable operating pressure

MAOP Maximum Allowable Operating Pressure (p_{umax} according to EN334)					
	Version	Control head			
		FE515 BP		FE515 TR	
		MPa	bar	MPa	bar
WITHOUT CE MARKING	all versions	0.515	5.15	0.515	5.15

Table 3 MAOP Maximum Allowable Operating Pressure without CE marking

Springs ranges and control heads

Control heads pressure ranges			
	Control head BP	Control head TR	Spring Table web link
Model	kPa mbar	kPa mbar	
FE515	1.3 - 18 13 - 180	18 - 50 180 - 500	TT00068

Table 4 Settings table

BP FE515-6/10/25 VERSION								
Spring item code	Spring colour	d	Lo	De	Spring range			
					kPa		mbar	
					Min.	Max.	Min.	Max.
64470358BL	Blue	1.6	41	34	1.3	1.7	13	17
64470359AR	Orange	1.7	41	34	1.7	2.2	17	22
64470360VE	Green	1.8	40	34	2.2	2.8	22	28
64470361RO	Red	2	38	34	2.8	3.8	28	38
64470362AZ	Sky blue	2.1	39	34	3.8	5.2	38	52
64470363BI	White	2.3	38	34	5.2	7.5	52	75
64470368MA	Brown	2.4	37	34	7.5	10.0	75	100
64470364GR	Grey	2.6	35	34	10.0	14.0	100	140
64470365NE	Black	2.8	35	34	14.0	18.0	140	180

d = Wire Diameter (mm) **Lo** = Spring Length (mm) **De** = External Diameter (mm)

Table 5 BP FE515-6/10/25 version calibration

TR FE515-6/10/25 VERSION								
Spring item code	Spring colour	d	Lo	De	Spring range			
					kPa		mbar	
					Min.	Max.	Min.	Max.
64470368MA	Brown	2.4	37	34	18.0	22.0	180	220
64470364GR	Grey	2.6	35	34	22.0	30.0	220	300
64470365NE	Black	2.8	35	34	30.0	40.0	300	400
64470366VI	Purple	3	38	34	40.0	50.0	400	500

d = Wire Diameter (mm) **Lo** = Spring Length (mm) **De** = External Diameter (mm)

Table 6 TR FE515-6/10/25 version calibration

General link to the calibration tables: [CLICK HERE](#) or use the QR code:





Accessories

For the pressure regulators:

- Slam shut
- IRV
- Nylon filter
- Fittings
- Thermal safety valve

Slam Shut

The FE is always supplied with an incorporated slam shut valve. The main characteristics of this device are:

OPSO Overpressure shut-off

 Compact dimensions

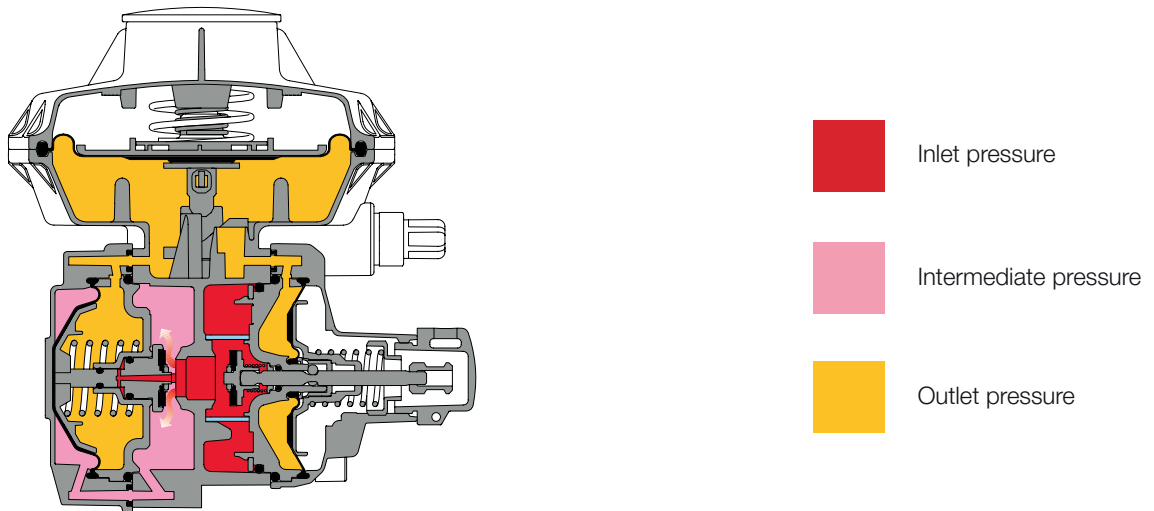

Figure 4 FE515 with slam shut

Slam shut types and range					
SSV Type	Model	Operation	Range Wh		Spring Table web link
			kPa	mbar	
FE515	BP	OPSO	2.5 - 30	25 - 300	TT00071
FE515	TR	OPSO	30 - 80	300 - 800	TT00071

Table 7 Settings table

SLAM-SHUT VALVE BP FE515-6/10/25

Spring item code	Spring colour	d	Lo	De	Spring range			
					kPa		mbar	
					Min.	Max.	Min.	Max.
6447038700	-	1	30	18	2.5	3.4	25	34
64470120BLU	Blue	1.1	29	18	3.5	5.0	35	50
64470121GI	Yellow	1.3	30	18	5.1	7.9	51	79
64470122VE	Green	1.3	36.5	18	8.0	10.9	80	109
64470123ROS	Red	1.5	31.5	18	11.0	15.9	110	159
64470124AZ	Sky blue	1.6	34	18	16.0	21.9	160	219
64470020MAR	Brown	1.7	35	18	22.0	30.0	220	300

d = Wire Diameter (mm) **Lo** = Spring Length (mm) **De** = External Diameter (mm)

Table 8 BP FE515-6/10/25 Slam-shut valve calibration

SLAM-SHUT VALVE TR FE515-6/10/25

Spring item code	Spring colour	d	Lo	De	Spring range			
					kPa		mbar	
					Min.	Max.	Min.	Max.
64470169GR	Grey	2	3	20	30.0	49.9	300	499
64470168BI	White	2.2	28	20.2	50.0	80.0	500	800

d = Wire Diameter (mm) **Lo** = Spring Length (mm) **De** = External Diameter (mm)

Table 9 TR FE515-6/10/25 Slam-shut valve calibration



IRV

The FE515 has an integrated token relief valve that discharges a small volume of gas into the atmosphere when the regulator exceeds the relief valve set point. It prevents slam shut valve (with manual reset) to trigger in case of abnormal non-hazardous overpressure conditions. The token IRV can be activated or deactivated in the field, if necessary. The most common conditions are:

- thermal expansion due to the day/night temperature variation
- quick on/off appliance
- small internal leakage

RELIEF VALVE BP FE515-6/10/25							
Pos.	Spring item code	Spring colour	d	Lo	De	Spring range (mbar)	
						Min.	Max.
1	64470389BI	White	8	37	15	7	7
2	64470213BL	Blue	0.9	37	15	8	10
3	64470029GIA	Yellow	1	35	15	11	19
4	64470027VER	Green	1.2	30	15.4	20	49
5	64470162ROS	Red	1.4	30	15.5	50	75
6	64470024BI	White	1.3	45	15	76	120

d = Wire Diameter (mm) **Lo** = Spring Length (mm) **De** = External Diameter (mm)

Table 10 Relief valve calibration BP FE515-6/10/25;

*the spring ranges refer to the differential between the regulator calibration and relief activation.

RELIEF VALVE TR FE515-6/10/25							
Pos.	Spring item code	Spring colour	d	Lo	De	Spring range (mbar)	
						Min.	Max.
1	64470029GIA	Yellow	1	35	15	75	149
2	64470027VER	Green	1.2	30	15.4	150	250

d = Wire Diameter (mm) **Lo** = Spring Length (mm) **De** = External Diameter (mm)

Table 11 Relief valve calibration TR FE515-6/10/25;

*the spring ranges refer to the differential between the regulator calibration and relief activation.

Nylon filter

The FE515 is equipped with a nylon mesh 100 microns | 140 mesh (FE515 standard version) and 300 microns | 50 mesh (FE515 arctic version) to prevent foreign particles, such as weld slag or PE shavings, to get stuck between the orifice and seat/disk thus preventing lockup for new installations.

The purpose of the nylon mesh is to provide protection to the FE515 and its accessories thus protecting the customers downstream piping system.



Figure 5 Nylon filter

Thermal safety valve

The thermal valve is a safety device that shuts the inlet gas flow in case of excessive ambient temperature, e.g., due to fire.

The valve is rated to stop the gas flow for up to 90 minutes at 1472 °F | 800 °C. The valve mechanism is composed of a seat, plug, spring, and a block of thermoplastic material. The block holds the valve open under normal conditions, and when the temperature exceeds a certain limit, it softens releasing the plug and stopping the flow. There are two sizes depending on the flow rate and pressure drop: TVD1 (typically for FE515 and FE) and TVD2 (typically for FEX).

Temperature limits:

212 °F +/- 18 °F | 100 °C +/- 10 °C

320 °F +/- 18 °F | 160°C +/- 10 °C

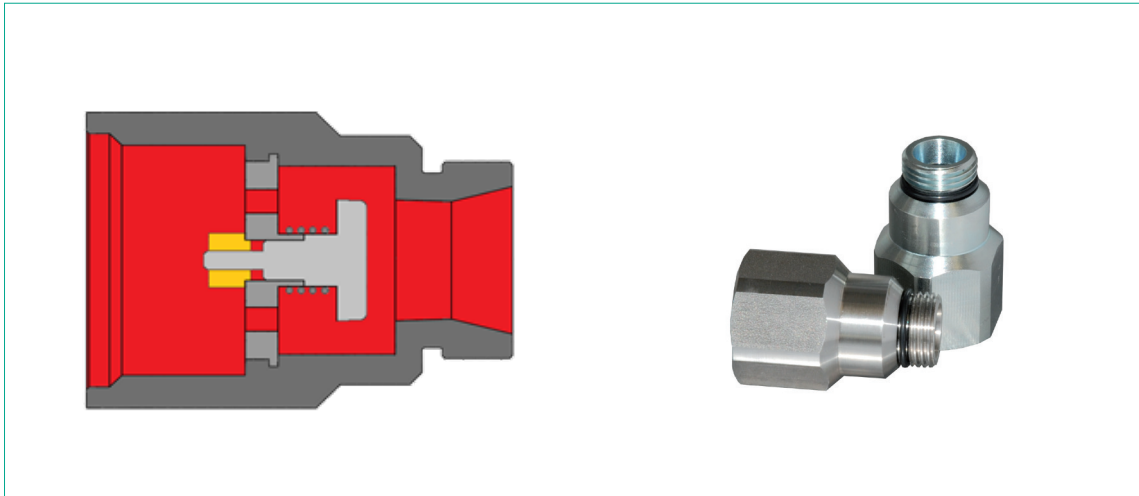

Figure 6 Thermal safety valve

Fire protection valve TVD1 (typically for FE515 and FE) pressure drop

Inlet pressure		Flow rate											
		1 m ³ /h 35 scfh		5 m ³ /h 175 scfh		9.9 m ³ /h 350 scfh		14.9 m ³ /h 525 scfh		24.8 m ³ /h 875 scfh		42.8 m ³ /h 1500 scfh	
kPa	mbar	kPa	mbar	kPa	mbar	kPa	mbar	kPa	mbar	kPa	mbar	kPa	mbar
6.9	69.0	0	0	0.3	3.0	1.0	1.0	3.73	37.3	5.5	55.0	-	-
13.8	138.0	0	0	0.25	2.5	0.87	8.7	3.48	34.8	5.0	50.0	-	-
34.5	345.0	0	0	0.2	2.0	0.75	7.5	3.23	32.3	4.5	45.0	12.0	120
69.0	690.0	0	0	0.15	1.5	0.62	6.2	2.49	24.9	3.5	35.0	8.0	80
≥ 276	≥ 2760	0	0	0.1	1.0	0.5	5.0	1.49	14.9	2.0	20.0	4.0	40

Table 12 Fire protection valve TVD1 (typically for FE515 and FE) pressure drop table

Fire protection valve TVD2 (typically for FEX) pressure drop

Inlet pressure		Flow rate											
		5 m ³ /h 175 scfh		9.9 m ³ /h 350 scfh		20 m ³ /h 700 scfh		50 m ³ /h 1750 scfh		75 m ³ /h 2600 scfh		100 m ³ /h 3500 scfh	
kPa	mbar	kPa	mbar	kPa	mbar	kPa	mbar	kPa	mbar	kPa	mbar	kPa	mbar
6.9	69.0	0.2	2.0	0.3	3.0	0.5	5.0	1.74	17.4	3.5	35	-	-
13.8	138.0	0.1	1.0	0.15	1.5	0.45	4.5	1.49	14.9	3.0	30.0	-	-
34.5	345.0	0.05	0.5	0.25	2.5	0.37	3.7	1.24	12.4	2.5	25.0	5.0	50.0
69.0	690.0	0	0	0.15	1.5	0.2	2.0	1.0	10.0	1.2	12.0	4.0	40.0
≥ 276	≥ 2760	0	0	0.1	1.0	0.15	1.5	0.5	5.0	0.9	9.0	1.0	10.0

Table 13 Fire protection valve TVD2 (typically for FEX) pressure drop table

Fittings

FE515 connections are customizable by fitting: one side is connected to the regulator body, the other to the piping. Fittings are selected depending on the regulator configuration, piping connection type and size, and end to end allowance. The fitting material can be brass or steel, according to the applicable standard.

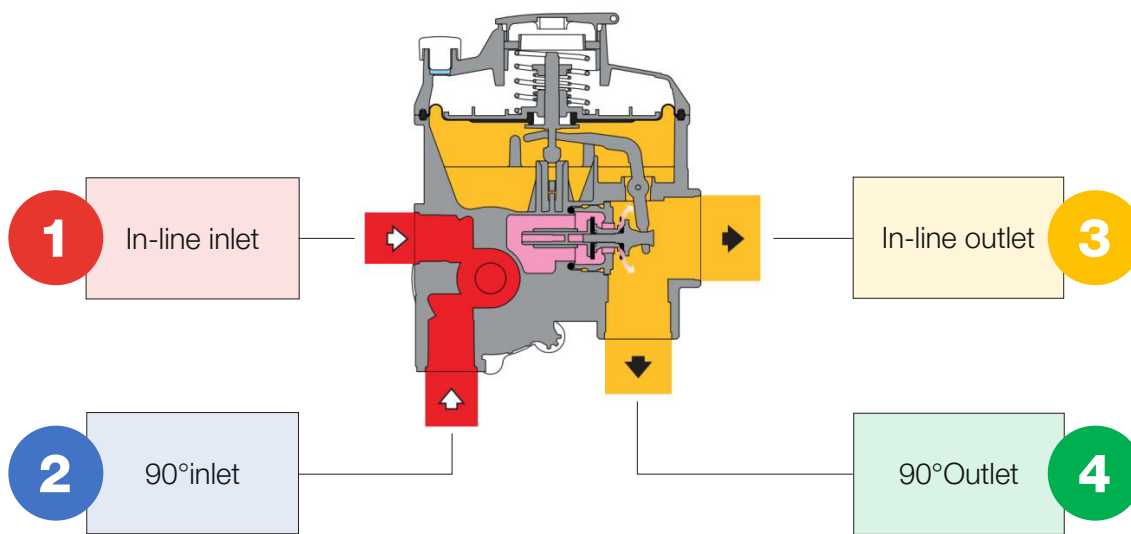

Figure 7 Fittings

Configuration	Piping connection type	Piping connection size	End to end (E-E) allowance
<ul style="list-style-type: none"> L: 1 & 3 S: 1 & 4 T: 2 & 3 U: 2 & 4 Q: 1 & 2 & 3 & 4 	<ul style="list-style-type: none"> Gas (UNI EN ISO 228 1:2003) Flat swivel joint (NF E29 533:2014 and NF E29 536: 2017) NPT (ASME B1.20.1, excluding connections with metal/metal sealing) Other on request 	<ul style="list-style-type: none"> 1/2" 3/4" 1" 1" 1/4 1" 1/2 	<ul style="list-style-type: none"> PF standard On request

Table 14 Fittings



Versions















		Models	
		FE515	FE515 NO MAX
Image			
Description		Standard version	Version without overpressure slam-shut device
Available versions	ZK Zamak version		
	AI Aluminium version		
	EFV Excess Flow Valve		
	OPSO Downstream overpressure slam-shut device		
	 Relief valve		
	 Customisable connections by fitting		
	 Outdoor installation not protected		

Table 15 Available versions of the FE515 regulator

Weights and dimensions

FE515 STD

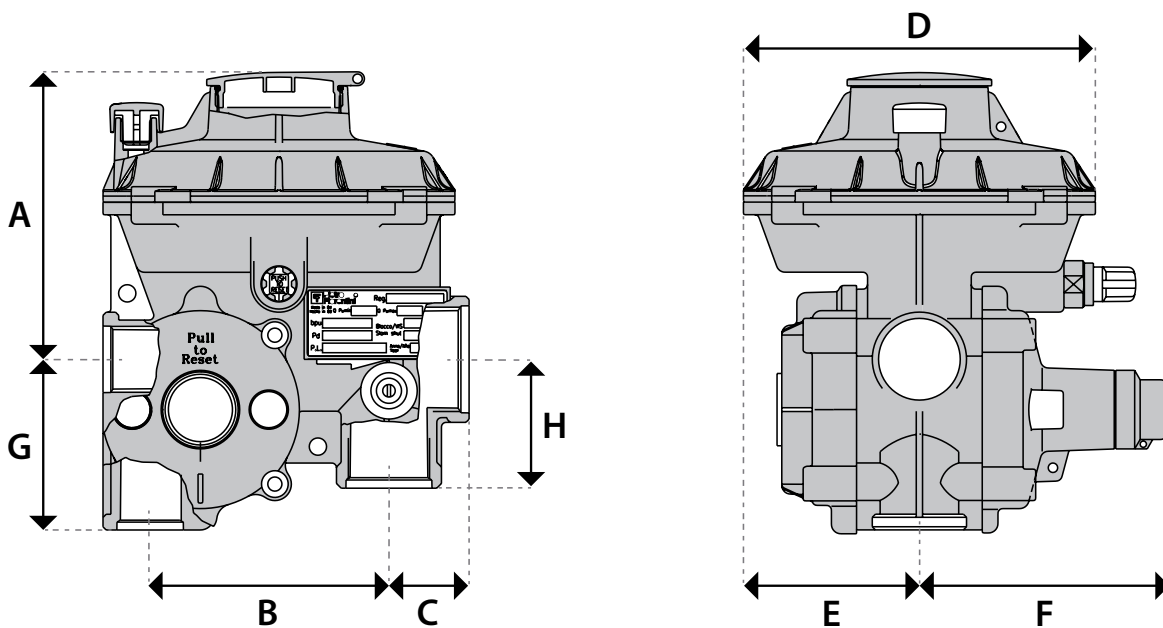

Figure 8 FE515 STD Dimensions

Weights and Dimensions (for other connections, please contact your closest Pietro Fiorentini representative)		
	[mm]	inches
A	91	3.6"
B	76	3.0"
C	25.5	1.0"
D	Ø112	Ø4.4"
E	56	2.2"
F	79	3.1"
G	54.3	2.1"
H	41	1.6"
Weight		
	Kg	pounds
Zamak regulator (without fittings)	1.35	2.98
Heavier compression fittings	from 0.15 to 0.7	1.57

Table 16 Weights and dimensions

FE515 NO MAX

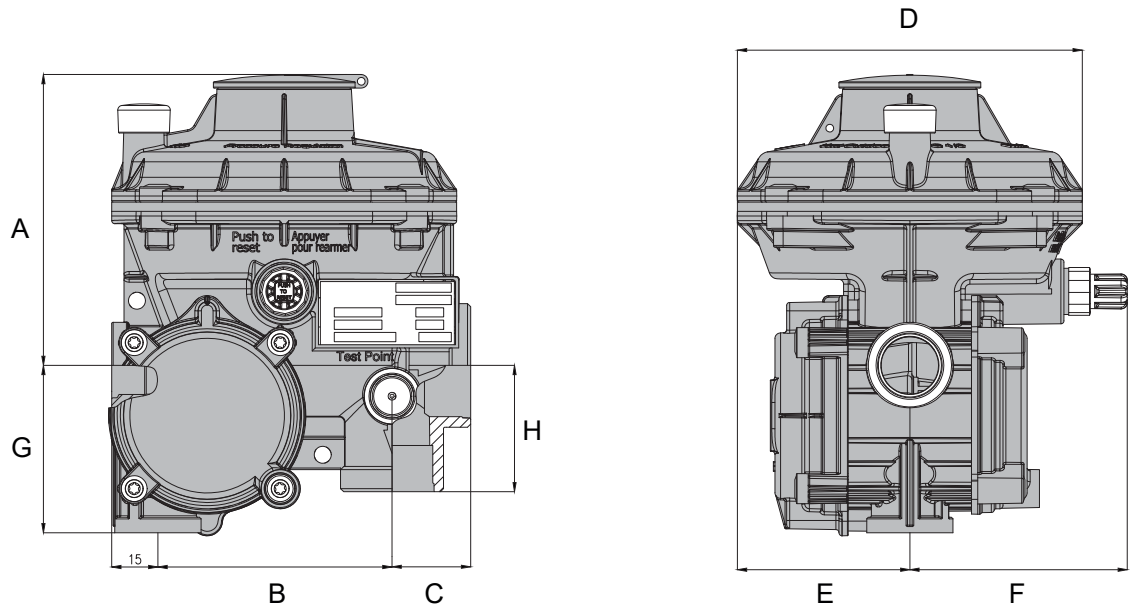

Figure 9 FE515 NO MAX Dimensions

Weights and Dimensions (for other connections, please contact your closest Pietro Fiorentini representative)		
	[mm]	inches
A	91	3.6"
B	76	3.0"
C	25.5	1.0"
D	Ø112	Ø4.4"
E	56	2.2"
F	71	2.78"
G	54.3	2.1"
H	41	1.6"
Tubing connections	eØ 10 x iØ 8 (on request imperial sizing)	
Weight	Kg	pounds
Zamak regulator (without fittings)	1.3	2.85
Heavier compression fittings	from 0.15 to 0.7	1.57

Table 17 Weights and dimensions

Customer Centricity

Pietro Fiorentini is one of the main Italian international companies with high focus on product and service quality.

The main strategy is to create a stable long-term oriented relationship, putting the customer's needs first. Lean management and thinking and customer centricity are used to improve and maintain the highest level of customer experience.



Support

One of Pietro Fiorentini's top priorities is to provide support to the client in all phases of project development, during installation, commissioning and operation. Pietro Fiorentini has developed a highly standardized intervention management system, which helps to facilitate the entire process and effectively archive all the interventions carried out, drawing on valuable information to improve the product and service. Many services are available remotely, avoiding long waiting times or expensive interventions.



Training

Pietro Fiorentini offers training services available for both experienced operators and new users. The training is composed of the theoretical and the practical parts, and is designed, selected and prepared according to the level of use and the customer's need.



Customer Relation Management (CRM)

The centrality of customer is one of the main missions and vision of Pietro Fiorentini. For this reason, Pietro Fiorentini has enhanced the customer relation management system. This enables to track every opportunity and request from Customer in one single point and make free the information flow.



Sustainability

Here at Pietro Fiorentini, we believe in a world capable of improvement through technologies and solutions that can shape a more sustainable future. That is why respect for people, society and the environment form the cornerstones of our strategy.



Our commitment to the world of tomorrow

While in the past we limited ourselves to providing products, systems and services for the oil & gas sector, today we want to broaden our horizons and create technologies and solutions for a digital and sustainable world, with a particular focus on renewable energy projects to help make the most of our planet's resources and create a future in which the younger generations can grow and prosper.

The time has come to put the why we operate before the what and how we do it.





**Pietro
Fiorentini**



Pietro Fiorentini

TB0079ENG



The data are not binding. We reserve the right
to make changes without prior notice.

fe515_technicalbrochure_AUS_revB

www.fiorentini.com